

# WETC

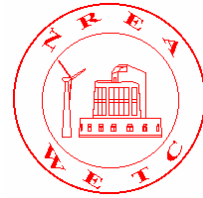

## **Power Quality Assessment Zafarana Wind Farm Transformer No. 2 [75 MVA] Installed capacity [64.9 MW]**

### ***Conducted By***

Eng. Amagd M. El-Hewehy  
Eng. El-Sayed M. Mansour

New and Renewable Energy Authority [NREA]  
Hurghada Wind Farm

# *WETC*

## **Power Quality Assessment Zafarana Wind Farm Transformer No. 2 [75 MVA] Installed capacity [64.9 MW]**

### ***Conducted By***

Eng. Amagd M. El-Hewehy  
Eng. El-Sayed M. Mansour

New and Renewable Energy Authority [NREA]  
Hurghada Wind Farm

***Abstract***

The report describes power quality assessment performed on transformer substation at Zafarana wind farm regarding the requirements of the standard specification ISO 9001 / 2000.

*contents*

<b>Title</b>	<b>Page</b>
1. Preface	5
2. Introduction	6
3. Objectives	7
4. Description of The Site	8
4.1 Zafarana Wind Farm	8
4.2 Zafarana Substation	9
5. Data Acquisition and Analysis	11
5.1 Measurement System	11
5.2 Description of Data Handling Routines	11
5.3 The Measurements	13
6. Measurements Analysis and Results	14
6.1 Bus-Bar Voltage Level	14
6.2 Line Current	20
6.3 Grid Frequency	24
6.4 Voltage Harmonics	26
6.5 Current Harmonics	29
6.6 Consumed Reactive Power	30
6.7 Produced Active Power	33
6.8 Capacity Factor	35
7. Conclusion and Recommendations	37
8. References	38
9. Appendix	39

## 1. Preface

### *Reasons for Power Quality Assessment*

Power quality is an issue of increasing importance. The main reason for this is the increasing demands from the customers with respect to security and quality of supply in order for them to rely on the public power supply in such a way that they do not have to take special measures to ensure that they can conduct their business without concern about the availability of computers, machines, appliances etc.

The varying of the power output from wind turbines has an impact on both the operation of the power system and on the power quality of the system. This impact increases as the level of penetration increases.

The influence on power quality is mainly on the level and fluctuations of voltage and frequency, the stability of voltage and frequency should not be degraded significantly as the controllers of systems are required to be able to prevent instability. Furthermore, the shape of the voltage should not be degraded by the inclusion of wind power in the system. If wind turbines or storage systems applying power electronics are included in the system, it should be ensured that the distortion of the voltage is within required limits.

The voltage level at the point of connection of the wind turbine to the grid will depend on the output from the wind turbines and on the consumer load. Situations where the voltage becomes high due to a high wind power production and a low consumer load will quite often occur. Design should limit maximum voltage to acceptable levels. Normally, nominal voltage  $\pm 10\%$  as instantaneous value or  $\pm 5\%$  as 10-minute average value.

Another important aspect is the power fluctuations. The power fluctuations create fluctuations in the voltage and they impose fluctuations in the diesel output. The voltage fluctuations have to be low to avoid disturbances e.g. in the light intensity. The power fluctuations do not only depend on the amount of installed wind power capacity, but also on whether the wind farm consists of a few large wind turbines or correspondingly more, but smaller wind turbines. The relative power fluctuation level basically is decreasing as the number of wind turbines is increasing and as the power output from the wind turbines is increasing.

## 2. Introduction

This wind farm measurements and studies program deals with Power Quality Assessment, the measurements for the study of power quality were carried out at Zafarana wind farm and have been approximately one month from 17/8/2005 to 14/9/2005.

This study should primarily be seen as an initiation and illustration of possibilities for activities and studies regarding wind farms at Zafarana, the main task of this study is to evaluate the wind farm performance and electrical properties, as well as the wind farm impact on power quality.

The installation of equipments has been accomplished with technical support and assist from protection and resident engineers at Zafarana substation.

- **Shaaban Ali Atwa**
- **Ehab El-Sayed Hassan**
- **Abdel-Fattah Helmy**

The CMS engineers at Zafarana wind farm have been checked the measurement system and data files, as well as they participated in installation of equipments, and the required data concerning wind speed, errors list during the measurement period had been compiled and reported by them.

- **Ibrahim Abdou**
- **Akmal El-Hewehy**

The analysis of measurements and printout were carried out at Hurghada WETC by:

- **Amgad El-Hewehy**
- **Sayed Mansour**

### 3. Objectives

The power quality is most often described in terms of voltage stability, frequency stability and phase balance. The frequency of larger power systems is normally very stable and therefore no problem. At autonomous grids where for example diesel generators are used, wind turbines may cause frequency variations.

Since wind turbine generators represent balanced three-phase sources, they will actually improve the phase balance of the grid when they are connected. Voltage stability can be subdivided into slow voltage variations, voltage dips, flicker, transient and harmonic voltage distortion.

The objective of Power Quality Assessment task is to:

- Illustrate the wind farm impact on power quality in terms of reactive consumption, voltage and frequency deviations.
- Analyze the measurements taken and relate the results obtained to international standards and theoretical calculations.

## 4. Description of The Site

### 4.1 Zafarana Wind Farm

Zafarana is situated along the coast of Suez Gulf, 250 km north of Hurghada and 110 km south of Suez, the wind farm (total area approx. 156 km<sup>2</sup>, length of 20 km and width of 8 km, annual average wind speed about 9.4 m/s) located 10 km north of Zafarana town towards Suez city. Figure (1) is an overview map of the Suez Gulf.

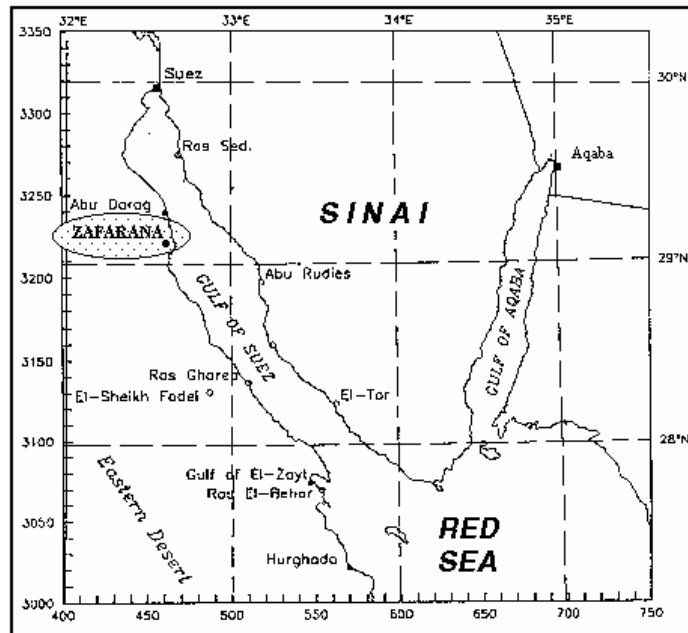

Figure 1

Zafarana wind farm presently consists of:

- Nordex wind turbines [(D1 & KFW1), 63 MW] with total capacity of 105 X 600 kW (N43 - 600 kW, 3 blades, stall regulation), the wind turbine is connected to a 50 Hz, 22 kV medium voltage system by a separate transformer of (800 kVA, 0.69/22 kV).
- Vestas wind turbines [(D2 & KFW2 & KFW3), 77 MW] with total capacity of 117 X 660 kW (V47 - 660 kW, 3 blades, pitch control), the wind turbine is connected to a 50 Hz, 22 kV medium voltage system by a separate transformer of (800 kVA, 0.69/22 kV), Figure (2) is an overview for part of zafarana wind farm.



Figure 2



### 4.2 Zafarana Substation

Zafarana wind farm has been linked to the national grid via a transformer substation located few kilometers north of the site; substation has two stationary transformers and mobile one. The substation has many incoming and outgoing coupling points, as shown in Figure (3).

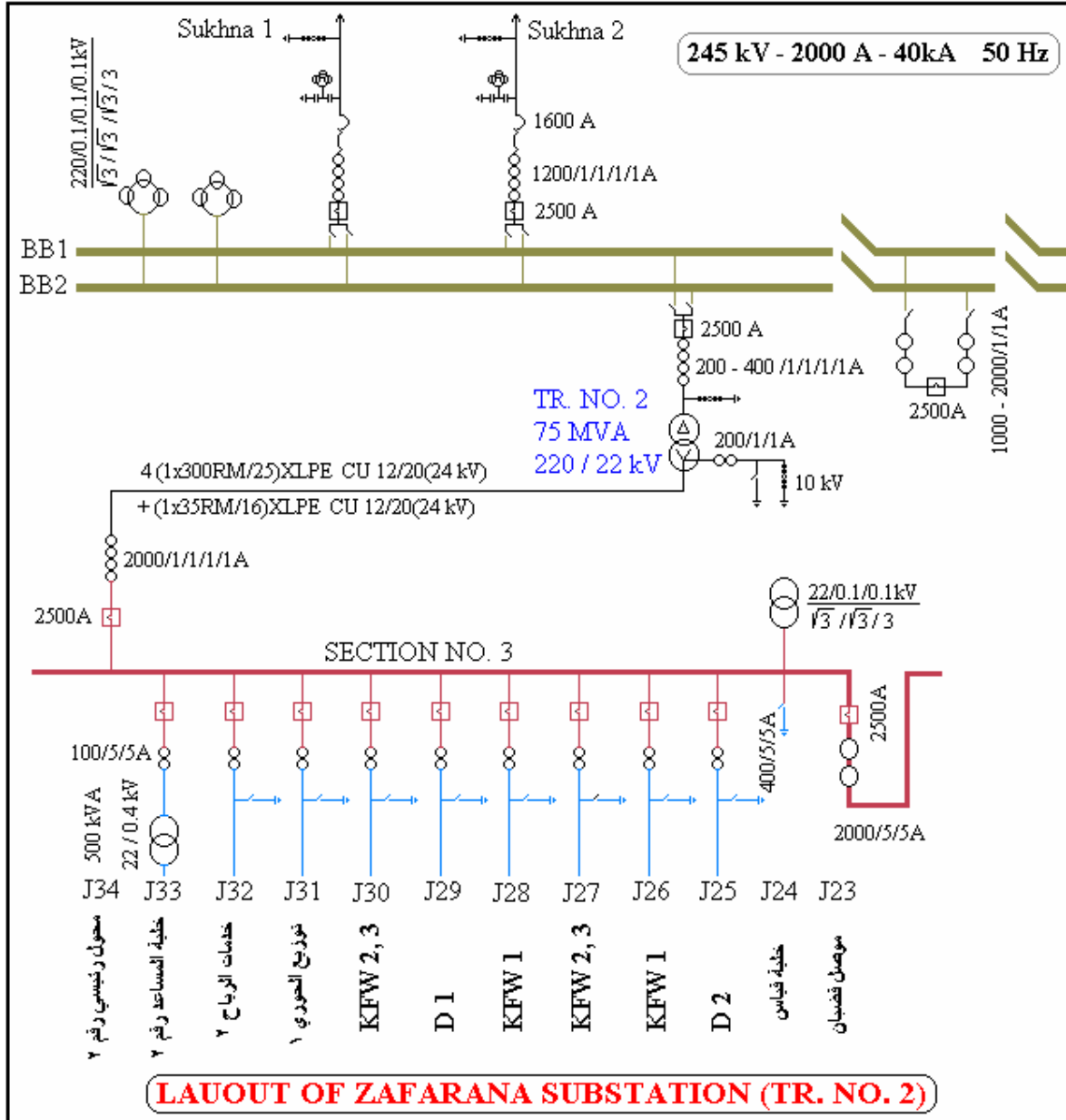

Figure 3

The substation presently consists of two transformers of 75 MVA, 220 kV for each (TR.1 of 54.2 MW and TR. 2 of 64.9 MW installed capacity), and mobile substation (25 KVA - 21.1 MW).

Each wind turbine is connected to a 50 Hz, 22 kV medium voltage system by a separate transformer of 800 kVA, 0.69/22 kV.

The turbines and its feeders connected to transformer No. 2 are shown in figure (4) (schematic diagram of Zafarana Substation, Transformer No. 2), [Appendix 9, Table (1)].

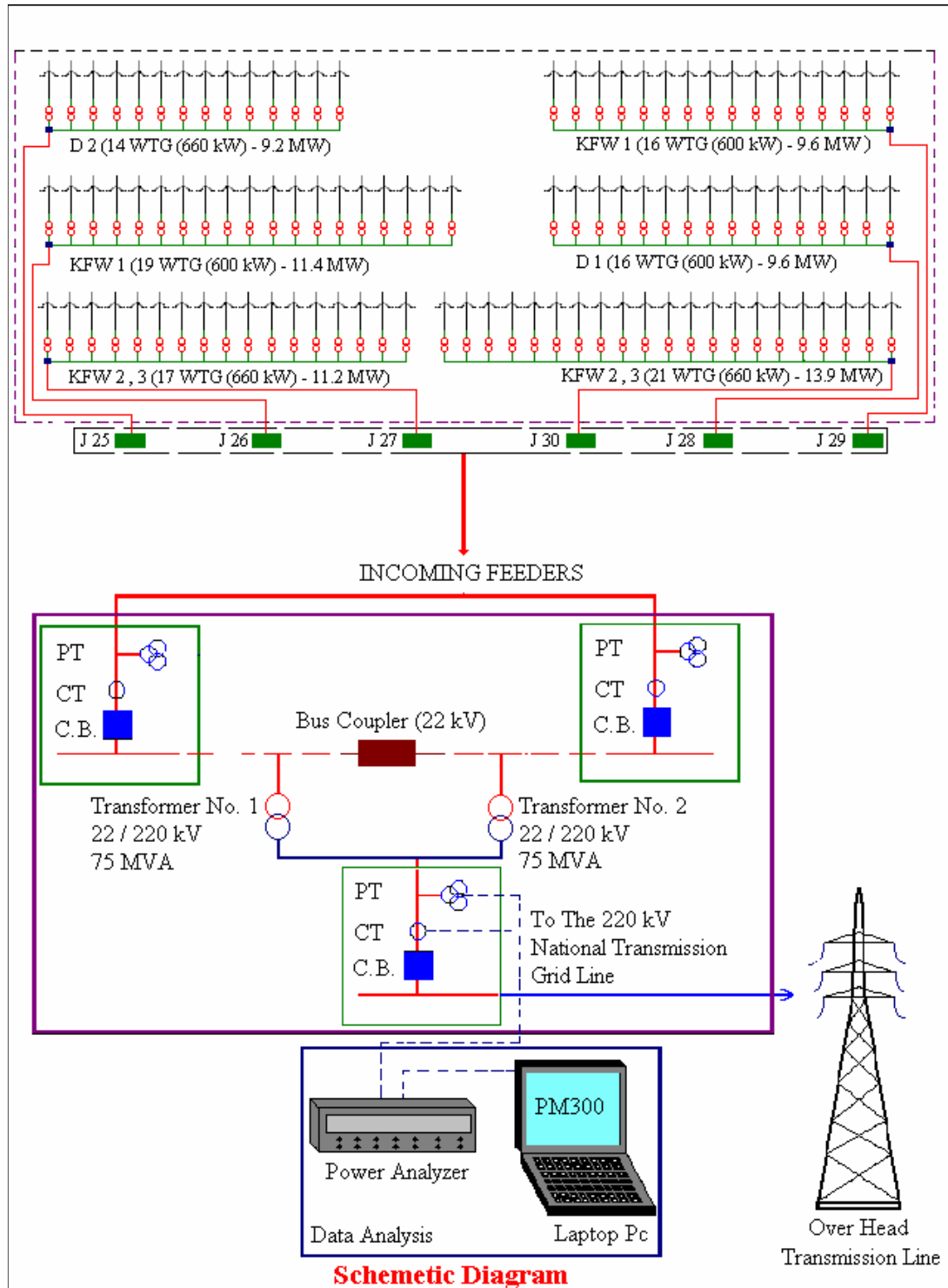

Figure 4

## 5. Data Acquisition and Analysis

### 5.1 Measurement System

The power analyzing system consists of a Voltech PM300 power analyzer, an Olivetti ECHOS 120 laptop PC, and a data logging program called PM300.EXE developed in the programming language Quick Basic 4.5 by Risø National Laboratory. The Voltech PM300 power analyzer performs the actual power measurements, whereas the Basic program PM300.EXE running on the Olivetti laptop computer controls the power analyzer and logs data from it.

The laptop PC running the program PM300.EXE was applied to control the power analyzer and to store data in the hard disk of the PC. The power analyzer was set-up to give total and fundamental values of the three phase active and reactive power, voltage and currents as well as the fundamental frequency, the total harmonic voltage distortion, the odd voltage harmonics up to 11<sup>th</sup> and the total harmonic current distortion, the sampling rate for storing data to the hard disk was set to 10 second, the measurement continued from 17/8/2005 to 14/9/2005 with one break due to grid failure [Appendix 9, Table (6)].

The logged raw data are stored in ASCII format on files (Time series) named with 8 digits [(00000000.txt), (name)(year)(month)(day).txt], [Appendix 9, Table (2)]

#### Voltech PM300 Power Analyzer

The main specifications:

Connection	: three-phase Voltage	Bandwidth	: DC to 250 kHz
Current accuracy	: 0.2 %	Current range (direct)	: 20 A rms (200 A peak)
Watt accuracy	: 0.4 %	Voltage range	: 1000 V peak

The power analyzer has a front panel from which it can be controlled manually and a display to show the measured values however, it is not able to store data.

#### Laptop CPU

The main specifications:

Processor	: 120 MHz Pentium	Memory	: 16 MB RAM
Screen	: SVGA Color Screen (600x800)	CD-ROM	: 6X Speed
		HD	: 1.2 GB

### 5.2 Description of Data Handling Routines

#### Basic program PM300.EXE

The Basic software program sets up the power analyzer and logs the measurements, the communication between the laptop computer and the power analyzer is based on RS232. Basic has been chosen as programming language because a simple starter program in Basic is given in the PM300 user manual for RS232 communication (Ref 5).

The first line in the set-up file is the name of the configuration file (Zaf.CFG), the configuration file is an ASCII file, which enables configuration of the PM300 before the data logging starts, the parameters that can be controlled are wiring, current and voltage scaling, range selection etc.

The second line in the input file is the name of the selection file (Zaf.SEL), this file is also an ASCII file. It determines which channels are logged (channel 1, 2, 3, sum, and possibly neutral) and which parameters are logged (power, reactive power, voltage, frequency, current, etc).

The third line in the set-up file is the name of an ASCII output file. As example, Za050914.txt has been selected. The head of the output file contains copies of the set-up file, the configuration file, and the selection file. Moreover, after setting the specified configuration, the PM300.EXE program gets all configuration codes from the power analyzer and copies them to the output files. This information is useful if the communication between the laptop PC and the power analyzer has failed. The remainder (and main part) of the output file is the logged data in columns with the time as the first column.

The sixth parameter in the set-up file is the sampling time. The PM300 does not specify how fast the sampling time can be, but our experience showed that it should be more than 3 seconds. The minimum sampling time depend on the specified set-up, for instance if specific time consuming calculations such as harmonics have been selected.

The last parameter is the number of measurement channels. This parameter can-in simple cases-be calculated according to the specifications in the selection file using the table (Page 64) in the RS232 manual. If this number is too small, the Basic program will make confusion in the output data file, and if it is too large, it will stop, waiting for data from the PM300.

### **The set-up file**

The Basic program PM300.EXE runs from DOS with a single parameter: the set-up file name. The set-up file is an ASCII file. For the power quality measurements described in this report, the set-up file Zaf.sup has been used.

The fourth parameter in the set-up file is the baud rate, this parameter must be the same in the input file as set manually on the PM300, because no communication is possible when the baud rate is conflicting.

The fifth parameter in the set-up file is the measurement time. In the example, it is 360000 second corresponding to 100 hours. This high value has been selected to ensure that the data logging is not interrupted by the program. When the user of the program wants to stop the data logging, the Break key can always be used, which will not be sent. An easy way to determine the number of measurement channels is to specify a very high value, and then run PM300.EXE. Then the program will stop after the first sample of data is send from the power analyzer. The program writes data both to the output file and to the screen. Therefore, the number of channels can be counted either from the screen or from the output file after the program has been interrupted.

Note that parameter 4 to 7 in the set-up file consists of data followed by a comment. The three first parameters, however, have only file names and no comments. Because of the simple reading procedure of the Basic program, this syntax must be followed.

### **Configuration file**

The configuration file specifies the configuration such as wiring, scaling etc. A complete list of the available parameters is given in the RS232 manual for the PM300 (Pages 58-63). The first two columns are data used by the PM300.EXE Basic program to configure the power analyzer. The following text is only for comments to the user. Note that the user must specify a comment, because PM300.EXE reads it from the file.

The frequency source (configuration parameter 14 and 15) can cause problems with keeping a fixed sampling time if the frequency of the current shall be calculated but the current is approximately zero. Therefore, the frequency source has been selected to voltage.

### **Selection file**

The original purpose of the selection file was only to enable the specification of selection commands such as: SEL: SUM and: SEL: WAT as described in the RS232 manual for the PM300 (Pages 64-66). However, the PM300.EXE Basic program has implemented this task simply by sending the contents of the selection file to the Power Analyzer. Consequently, the selection file can also be used to specify other commands than selection commands to the power analyzer. As an example of that, the command: HMX : ODD 11 is added to the configuration file below, specifying odd harmonic orders up to 11 the harmonic [RS232 manual (Page 40)].

### **Data Analysis files**

A software program called PM300sta.EXE developed by Risø were used to generate statistical file (STA, 10-minute Average) [Appendix 9, Table (3)]. from time series file (TXT, 10-sec)

As well as another software program (Consolstanal.EXE, input, listfile) developed by Risø were used for generate two output files, the first is statistical file (the mean value for continuously 10 minute, daily “measurement period”) and the second is diurnal file (the mean value as 10-minute over 24 hour throughout measurement period from midnight to midnight), [Appendix 9, Table (4)].

The data analysis were performed using Microsoft Excel.

## **5.3 The Measurements**

The measurements were carried out at Zafarana substation on 22 kV Bus Bar, the substation has no single feeder with the total output power of the wind farm, thereby a direct measurements of the total output power is not possible. At substation there are two permanent transformer and mobile one, in order to measure the total power, the currents of the three transformers (TR. 1, TR. 2 and mobile one) must be summed simultaneously using summation transformer where it was not available during the measurements period.

According to the situation at zafarana substation, it is decided to achieve the measurements individually on transformer No. 2 and transformer No. 1, thereby the measurement equipments had been connected to the secondary side of the potential transformer (22000/100 V) to measure the voltage, as well as the current measured using current clamps (1 mV: 1 mA) on the secondary side of the existing current transformer (2000:1 A) of transformer No. 2.

The measurements on transformer No. 1 will be performed after the completion of first stage.

## 6. Measurements Analysis and Results

### Key data for Zafarana wind farm measurements

ITEM	DESCRIPTION
Start Date	17/8/2005
Stop Date	14/9/2005
Nominal power	64.9 MW
Max. output power (10-minute average)	55.06 MW
Min. output power (10-minute average)	- 0.3 MW
Mean. output power (10-minute average)	42.12 MW
Mean PF (10-minute average)	0.91
Mean CF (10-minute average)	64.9
Mean Bus-Bar Voltage (10-minute average)	21.95 kV

### 6.1 Bus-Bar Voltage

The valid measurement with the power analyzer on 22 kV Bus-Bar give basis for assessing the voltage quality and to analyze the impact of the wind farm on the voltage quality.

Plot (1) is the statistical data of the mean value of the Bus-Bar voltage, the voltage level during the measurement period between 21.06 kV and 22.73 kV, or in other words 22 kV +3.3% and - 4.27%.

International standard (IEC - Ref 3) specifies that the voltage level should be within  $\pm 5\%$  of its nominal value measured as 10-minute average data or  $\pm 10\%$  of its measured instantaneous values.

From the results obtained it could be stated that the voltage level when reaches to its maximum value still within the required limit, meanwhile it is critical when reaches to its minimum value.

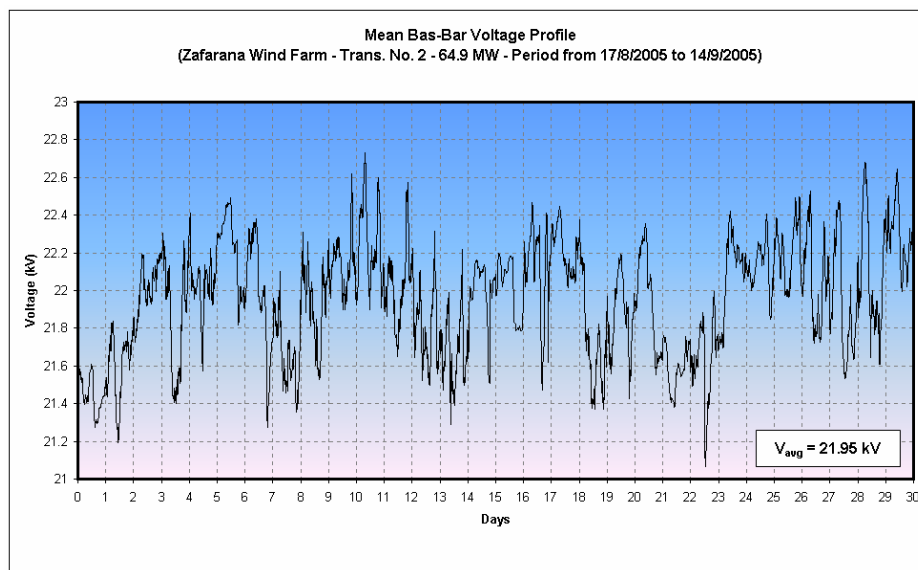

Plot 1

Plot (2) is the statistical data as 10-minute average values of the Bus-Bar voltage plotted versus the 10-minute average values of the output active power from the wind turbines.

In this plot, two different situations are clearly visible. The first situation (scattered points) where the Bus-Bar voltage seems to be constant independent of the output power from the wind turbine (from 0 to 30 MW).

Then the second situation (cloudy points) where voltage level decreases for increasing the active power from the wind turbines (from 30 to 55 MW).

The two different situations are predicted, since the wind farm capacity presently reached to 140 MW, which is significantly high-generated power.

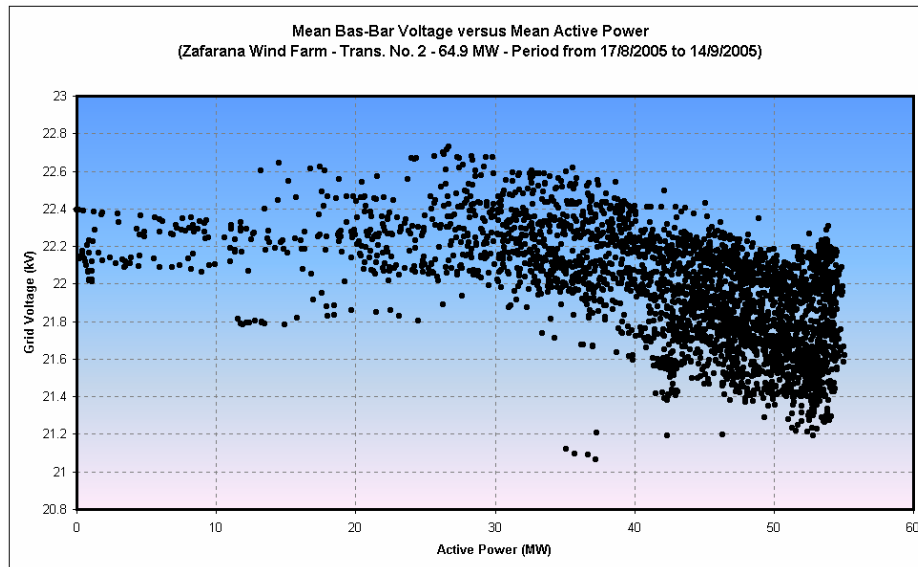

Plot 2

Plot (3) is the statistical data of the three phase voltages as 10-minute average during the measurement period., the three phase voltages limits are indicated below:-

Phase No. 1 varies from 12.07 kV to 13.04 kV, or 12.7 kV + 2.66 % and - 4.95 %.

Phase No. 2 varies from 12.40 kV to 13.40 kV, or 12.7 kV + **5.50 %** and -2.14 %.

Phase No. 3 varies from 11.98 kV to 12.93 kV, or 12.7 kV + 1.80 % and **-5.70 %**.

The international standard specifies that the voltage level should be within  $\pm 5\%$  of its nominal value measured as 10-minute average data.

From the results obtained, it could be stated that the maximum and minimum values of phase No. 2 and phase No. 3 respectively, are critically out of range.

**Hint:** The amplitude of the resulting voltage, drop or rise will depend on the impedance of the feeder between the wind turbine and the substation. The stability of the grid will be sensitive to the ratio of X/R where (X) is the source impedance's reactance and (R) is the source impedance's resistance.

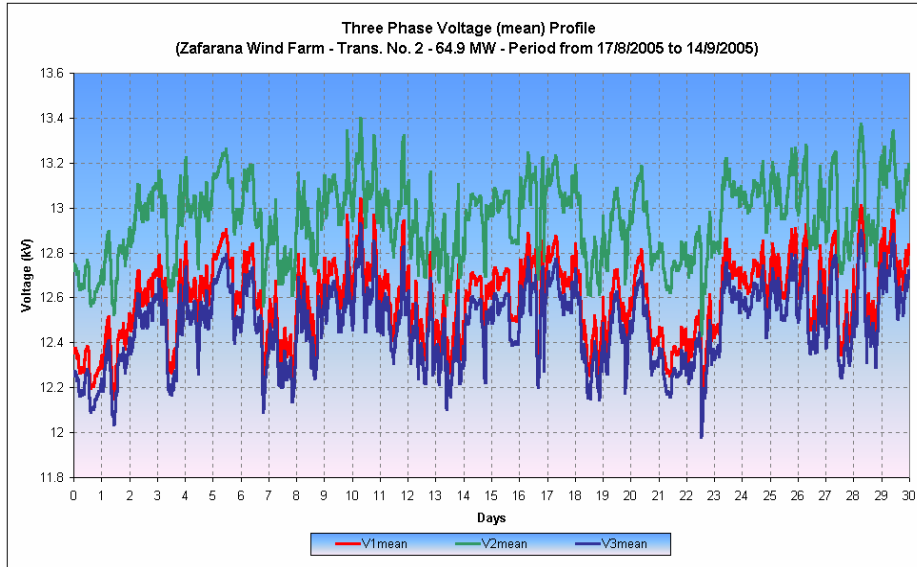

Plot 3

Plot (4) is the absolute value of the frequency distribution as 10-minute average value of the Bus-Bar voltage, there are two different situations are clearly observable in the plot, the first is the distribution is not symmetrical around the nominal value (22 kV) ( $Z_0$ ).

The second is that two peaks are noticed at 22.1 kV and 22.2 kV, as well as the voltage range is quite narrow due to the wind farm connected to a large network. The voltage varies almost from 21.3 kV ( $Z_1$ ) to 22.7 kV ( $Z_2$ ) during the measurement period.

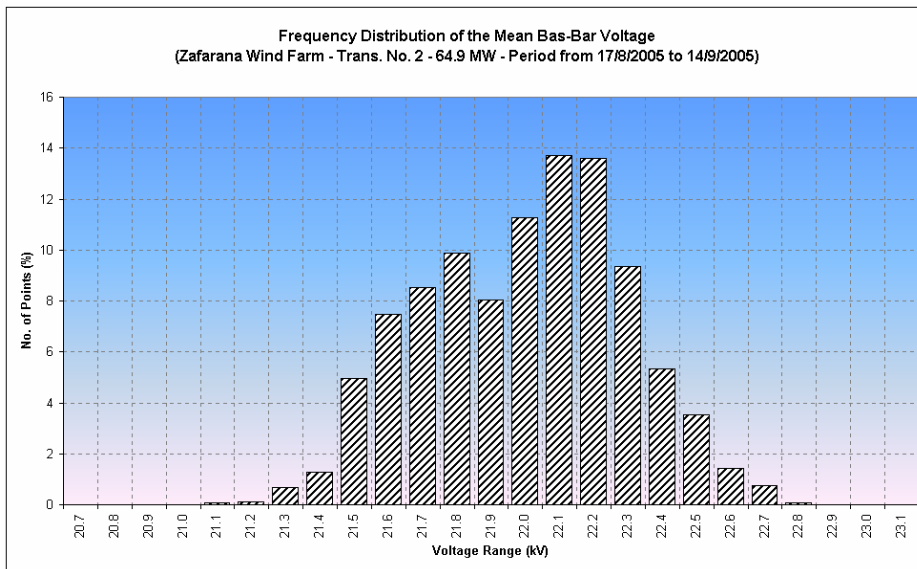

Plot 4

**Hint:** for a given set of values and a given set of bins (intervals), a frequency distribution counts how many of the values occur in each interval.



Plot (5) is the voltage change relative to the initial (nominal) value “22 kV” from one 10-minute value to the next, the majority of the relative voltage changes are between +2.2 % and -2.6 % as magnitude (bin).

The plot shows that voltage varies in a small range and very few values above +3 % occur. No significant peaks are noticed in the plot, as well as the distribution is not symmetrical around  $Z_0$  (when  $V_{mean} = V_{initial}$ ).

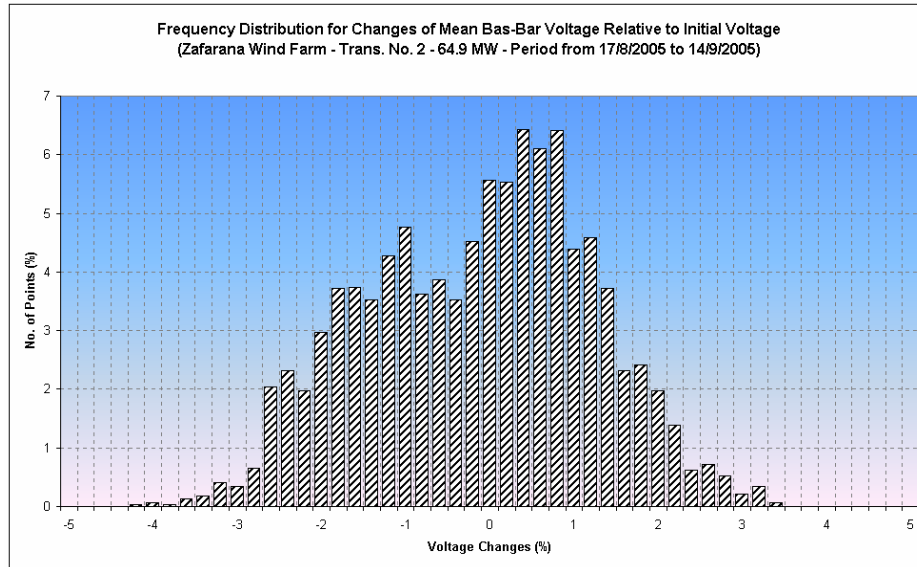

Plot 5

$$V_{relative} = \left[ \frac{V_{mean} - V_{initial}}{V_{initial}} \right] * 100$$

Plot (6) is the diurnal pattern for the mean, maximum and minimum value of the Bus-Bar voltage, the plot is the typical value of the Bus-Bar voltage profile, since the plot is the average value throughout the measurement period.

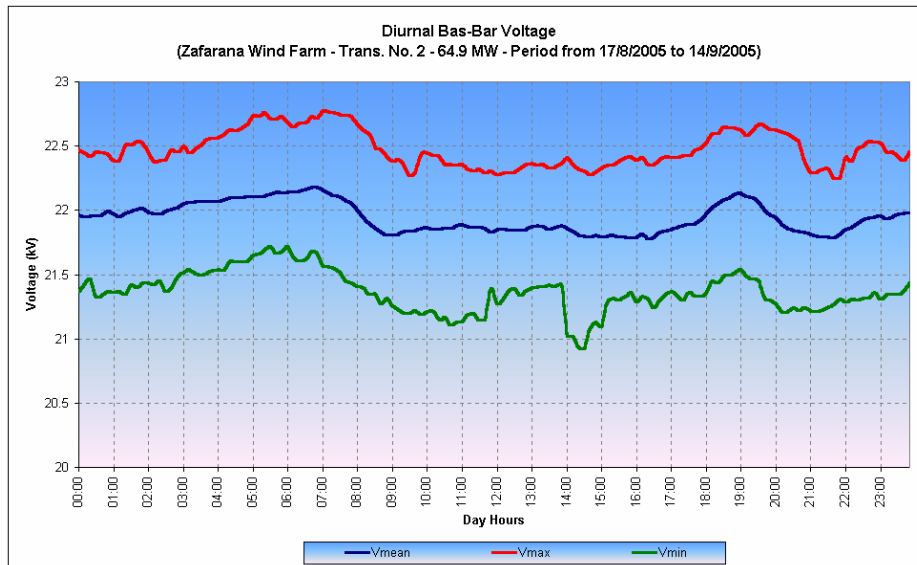

Plot 6

Plot (7) is the diurnal pattern of the three phase voltages as 10-minute average, it is clearly seen in the plot that phase No. 1 and phase No. 3 are slightly lower than phase No. 2.

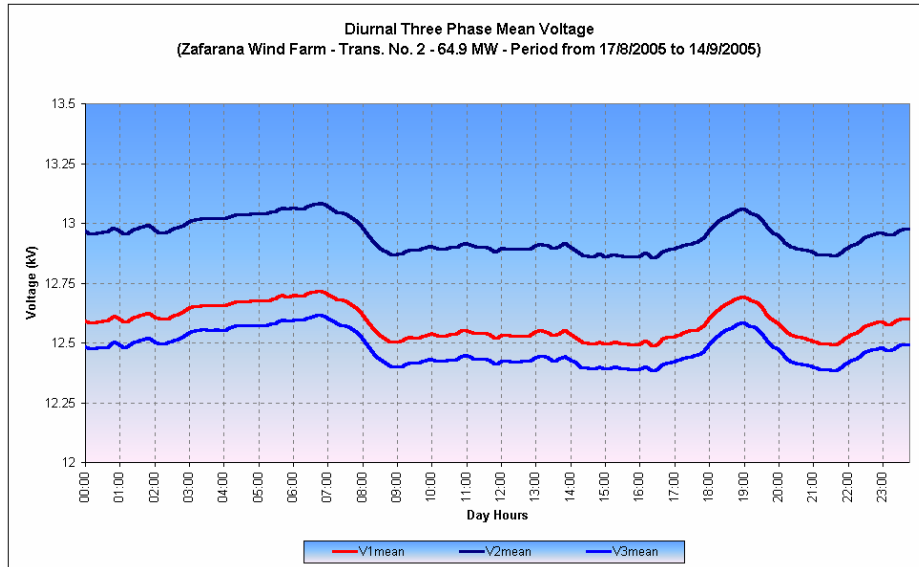

Plot 7

Plot (8) is the diurnal pattern of the grid voltage and grid frequency, the plot shows that the grid frequency is almost constant independent of the Bus-Bar voltage level.

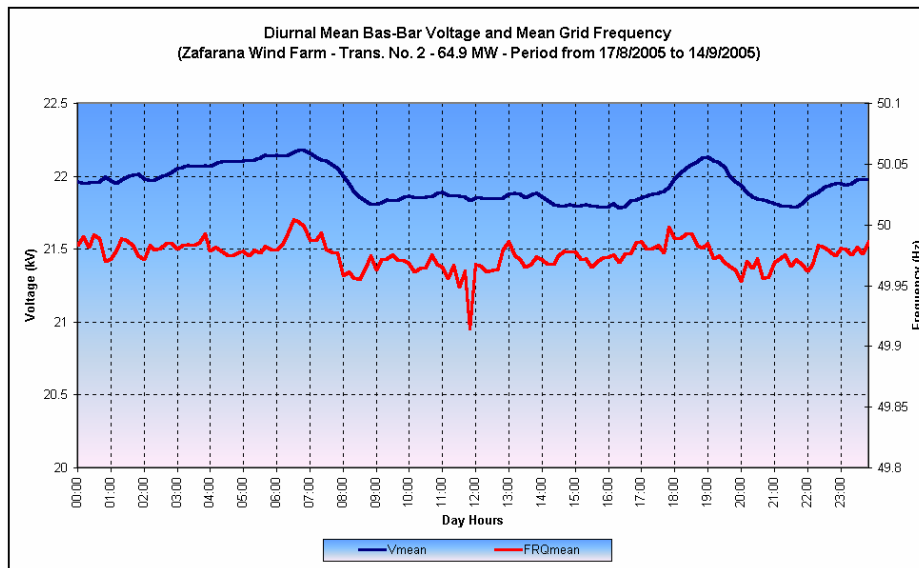

Plot 8

Plot (9) illustrates the diurnal pattern of the Bus-Bar voltage and active power, the plot shows that the voltage varies reversely to the active power. Assuming a fairly relation between the voltage and the output power, it is obviously seen in the plot that the maximum value of active power (50.9 MW) corresponds to minimum value of voltage (21.5 kV) as 10-minute average value.

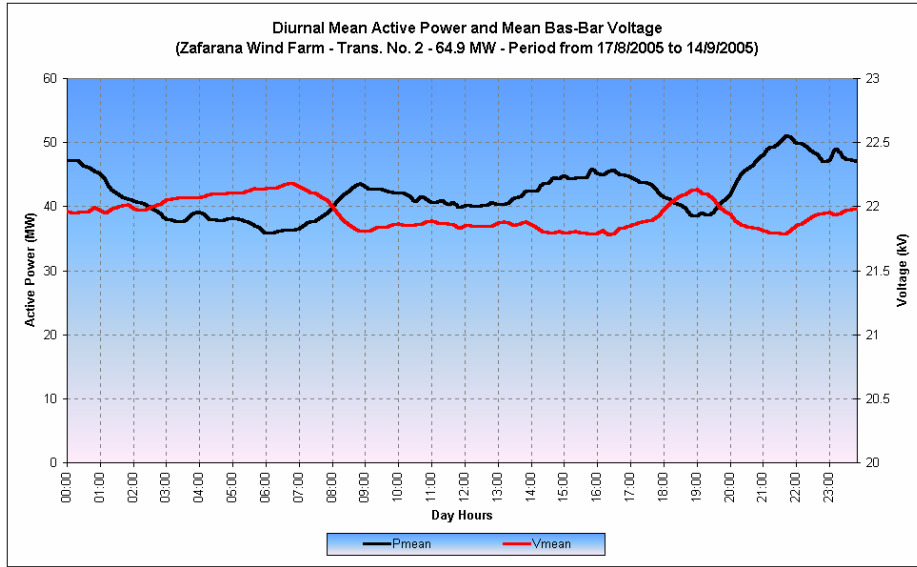

Plot 9

Plot (10) is the diurnal pattern of the Bus-Bar voltage and mean wind speed, the plot indicates that the voltage values seem to vary reversely to the wind speed values. The plot corresponds with voltage-power correlation as shown in Plot (9).

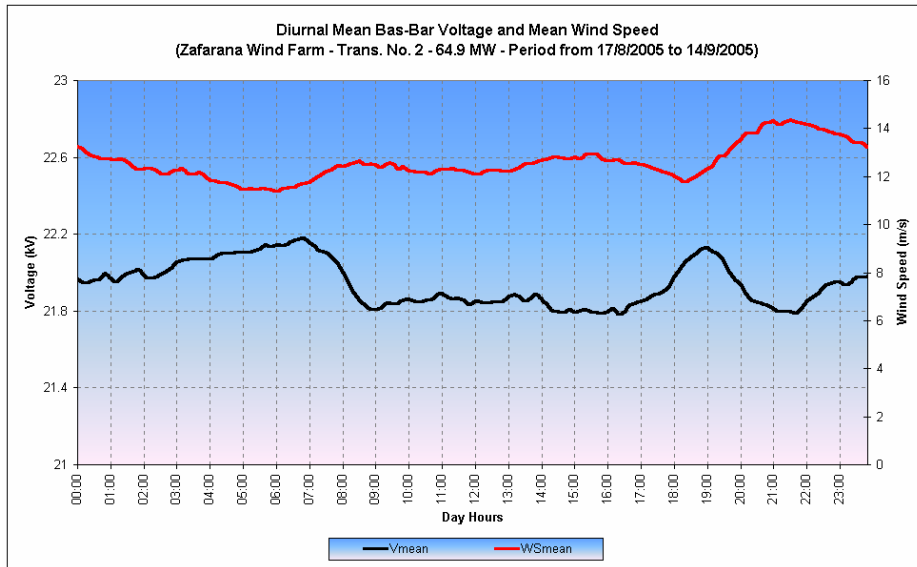

Plot 10

### 6.2 Line Current

Plot (11) is the statistical data of the line current as 10-minute average during the measurement period.

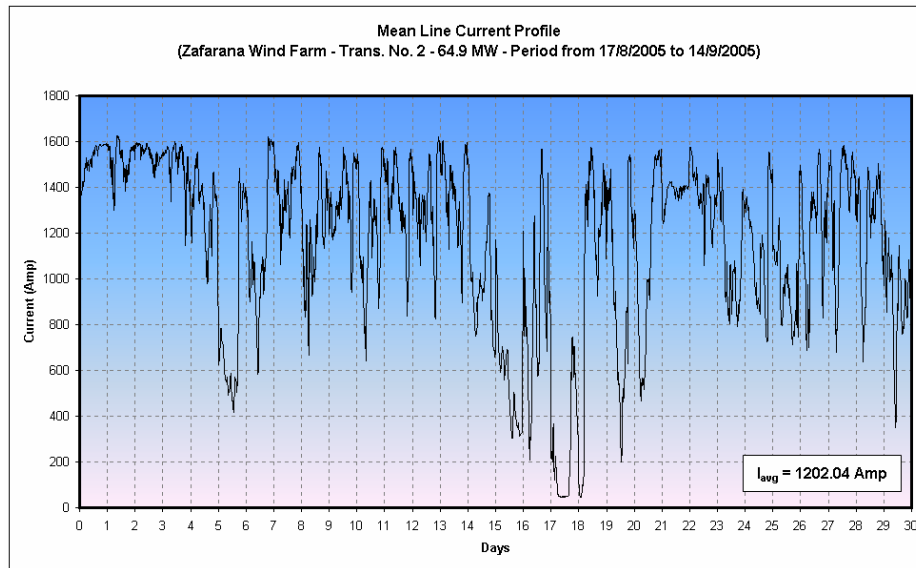

Plot 11

Plot (12) is the diurnal pattern of mean, maximum and minimum values of line current. The plot is the typical value of the line current profile as the plot is the average of the measurement period.

The maximum value looks constant; meanwhile, the mean and minimum values look fluctuated very much.

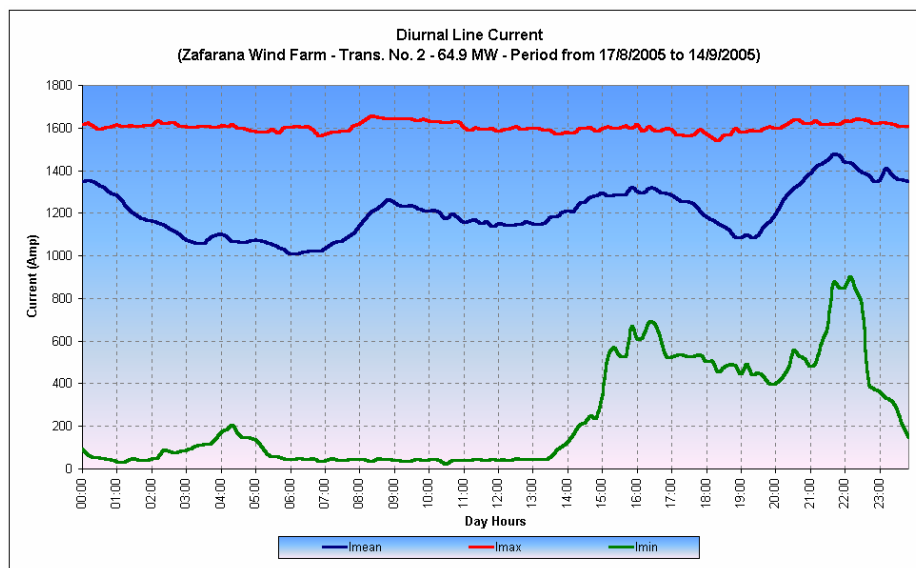

Plot 12

Plot (13) is the statistical data of a correlation between the output active power and line current as 10-minute average value, the plot shows that the power varies proportionally to the line current; however, there is a situation where, a small deviation has been occurred.

The raw data (Time series as 10-sec.) has been investigated carefully, and it is concluded that the current reading of phase No.1 was not match (lower than) with the other two phases, only on day 7/9/2005. The reason for this still unknown.

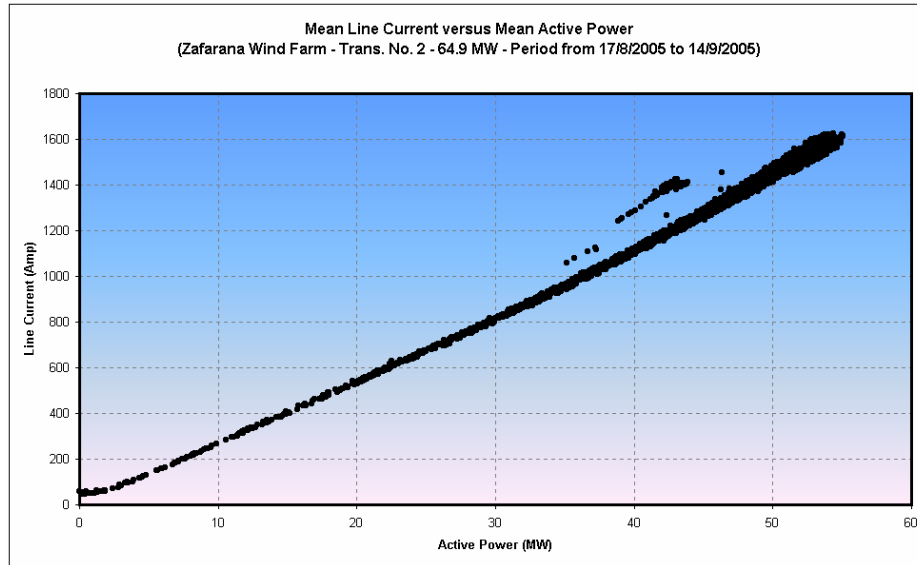

Plot 13

Plot (14) illustrates the diurnal pattern of active power and line current as 10-minute average, the plot shows that the output power varies proportionally to the line current.

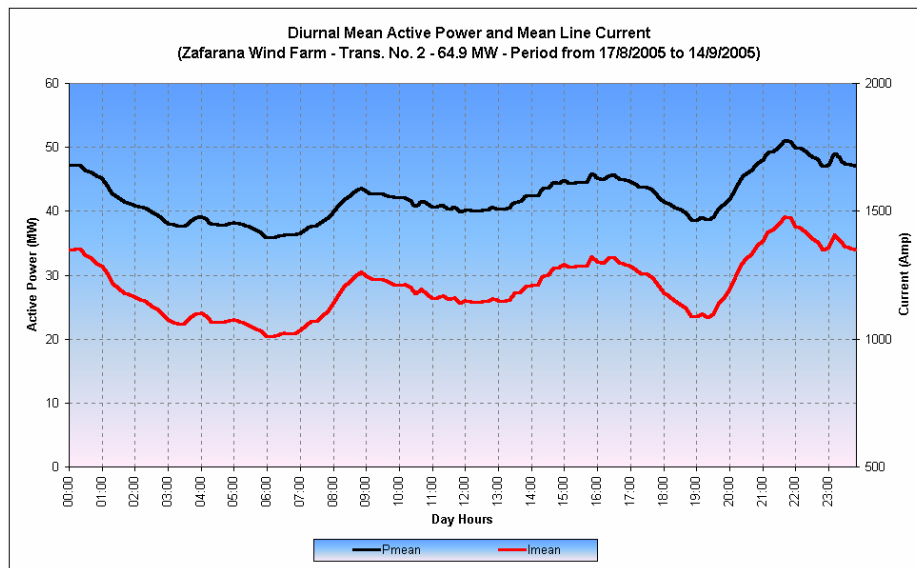

Plot 14

Plot (15) is the diurnal pattern of three phase line currents as mean value. The plot is the typical values of the three-phase currents profile as the plot is the average throughout the measurement period

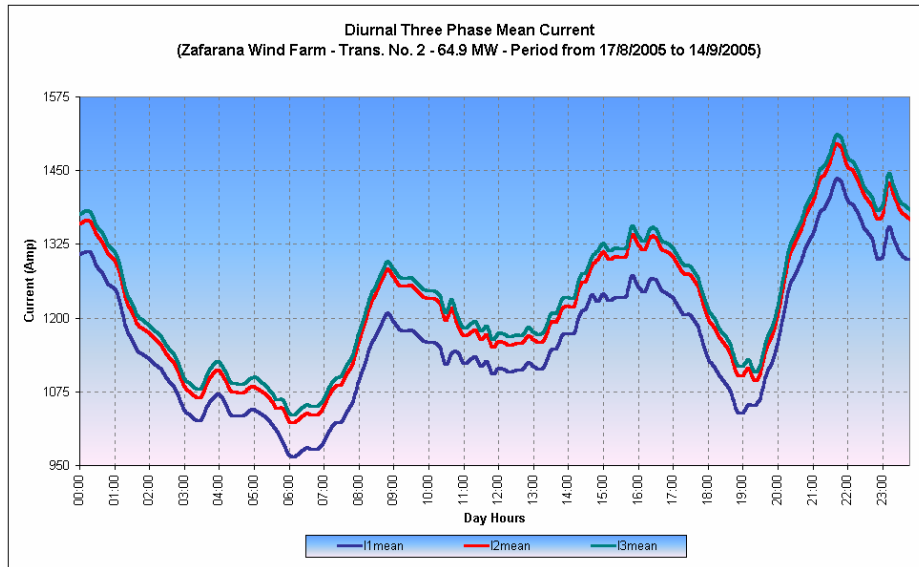

Plot 15

Plot (16) is the statistical data of the load factor as 10-minute average value; the load factor is 0.96 as an average value as shown in the plot.

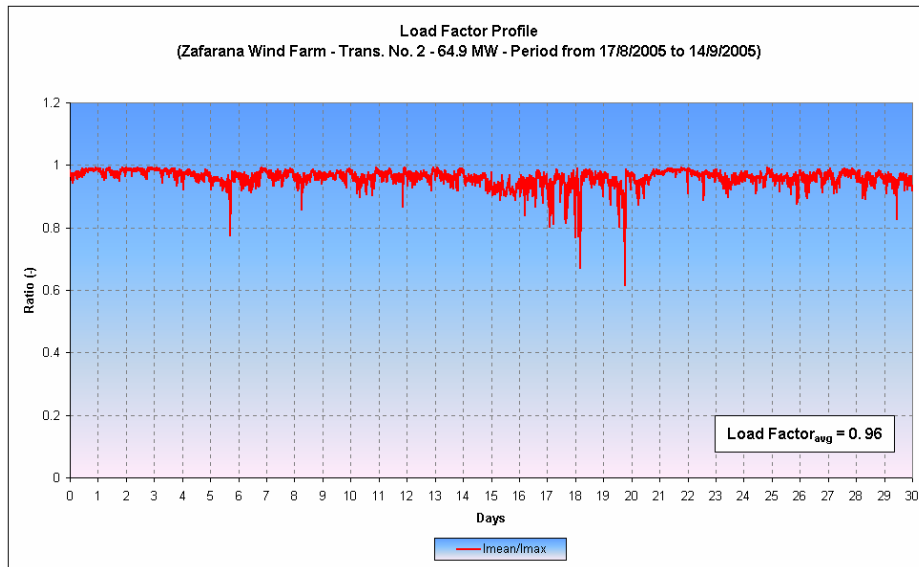

Plot 16

Plot (17), (18) and (19) illustrate the ratio between max, min and mean values of the statistical data as 10-minute average value respectively.

The ratio looks constant even though the two peaks and drops seen in the plots. The interpretation for the two peaks and drops are related to low power production at low wind speed.

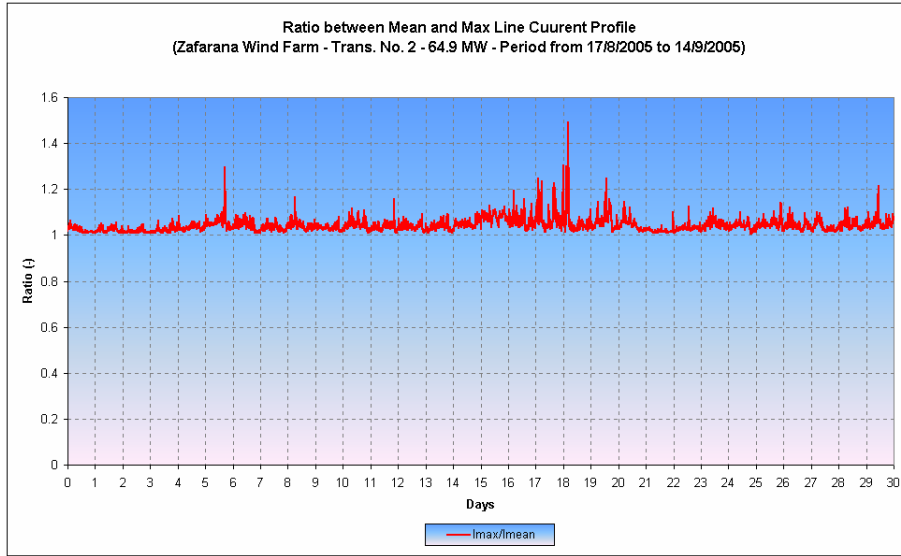

Plot 17

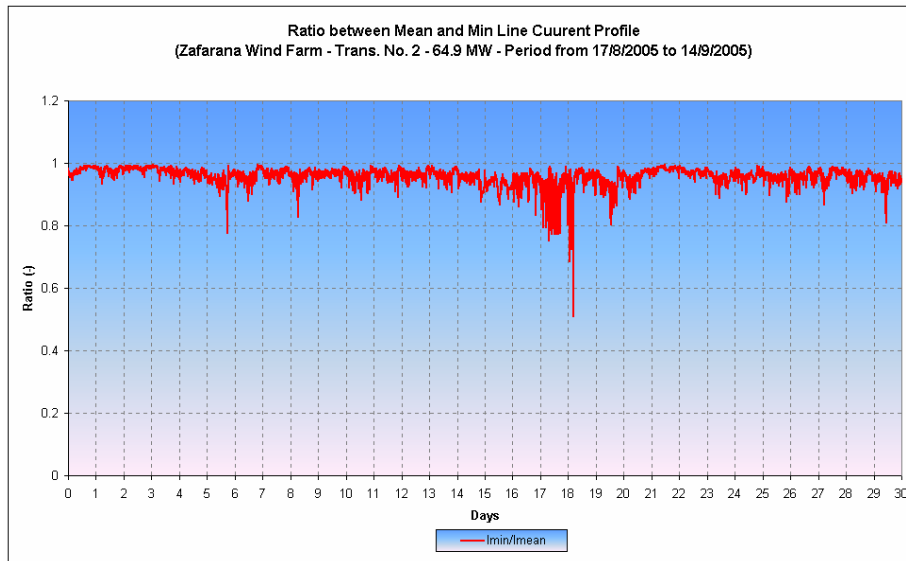

Plot 18

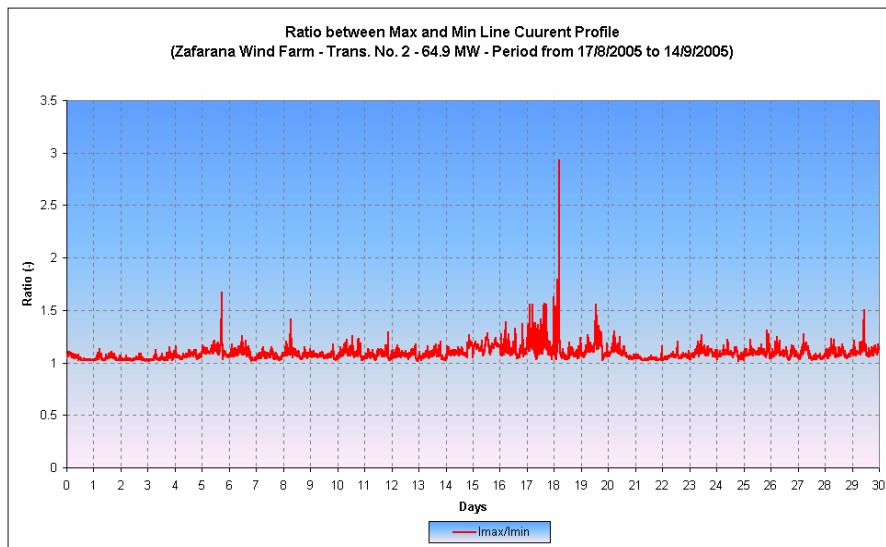
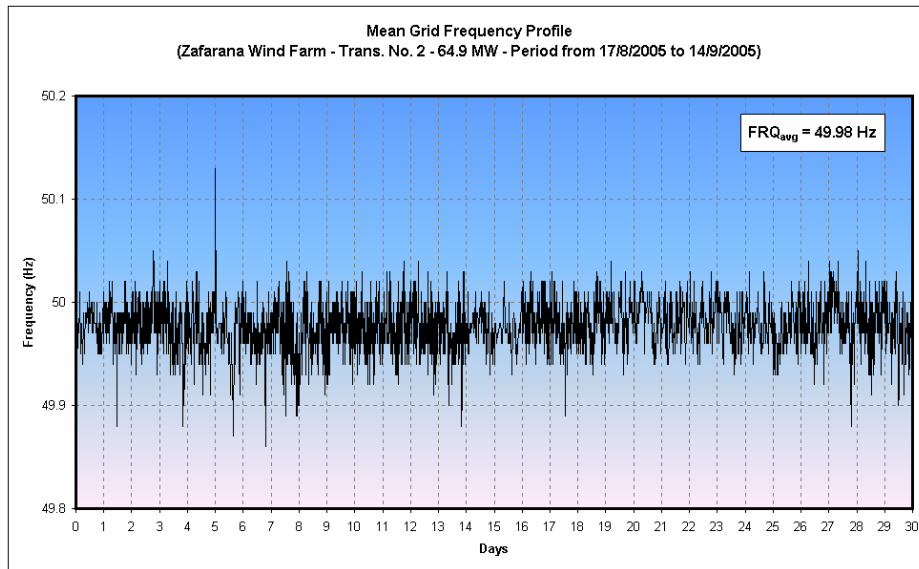

Fig 19

### 6.3 Grid Frequency

Plot (20) is the statistical data of the grid frequency profile as 10-minute average values. It is seen from the plot that the grid frequency is very stable independent of other grid parameters; the average value is 49.96 Hz during the measurement period.

The plot shows that the frequency lays within a narrow band between 49.86 Hz and 50.13 Hz that comply with the international standards (50 Hz  $\pm$  1 %).



Plot 20

Plot (21) is the statistical data of a correlation between the grid frequency and active power, the grid frequency remains constant independent of the produced power from the wind turbines.

It is noticed also that the cloudy points in the plot is quit wide at high output power from the farm, however, the changes in the frequency still in a very small range.

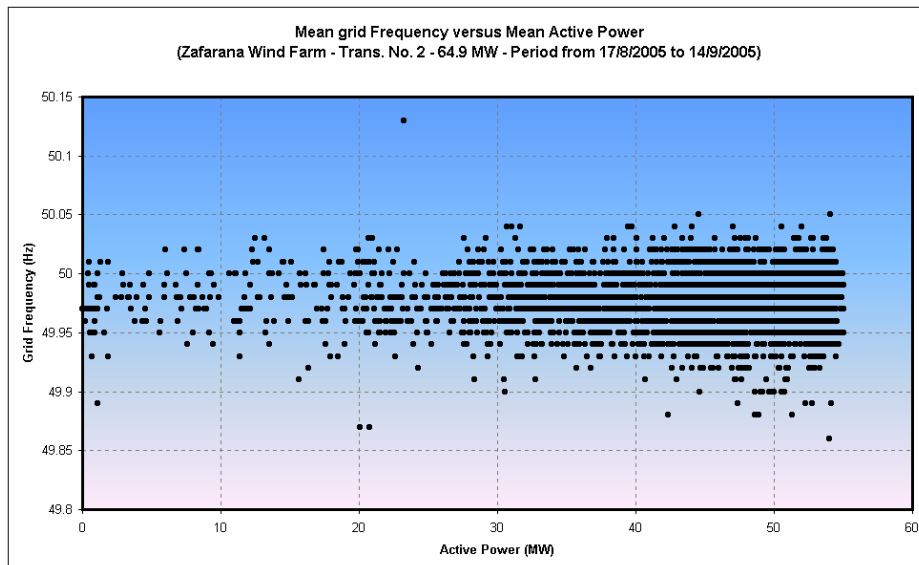

Plot 21



Plot (22) is the absolute change of the frequency distribution as 10-minute average values of the grid frequency, it is obviously seen in the plot that, the frequency is well controlled with only small deviations from the 50 Hz nominal setting, these small deviations are slightly above 50 Hz.

The grid frequency is quite symmetrical and triangular around 49.98 Hz, varying from 49.92 Hz to 50.03 Hz.

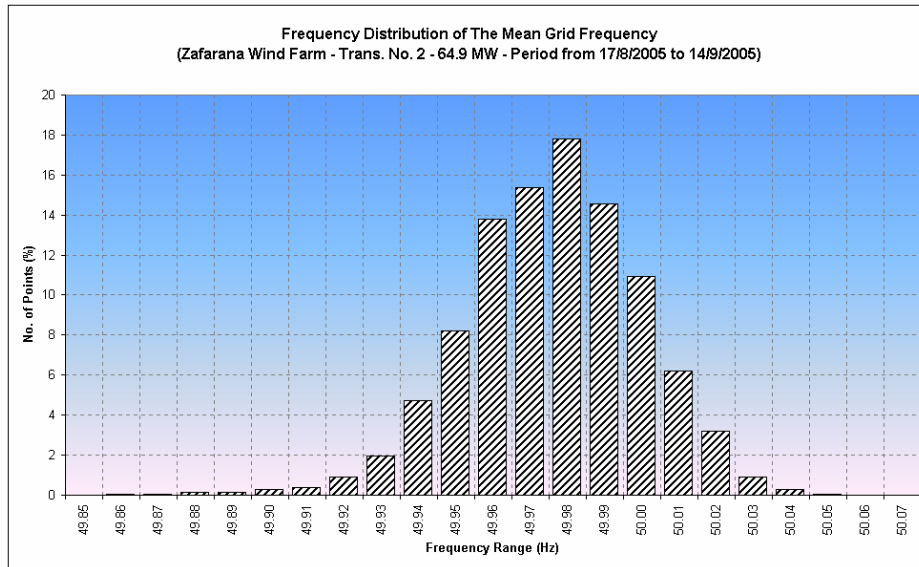

Plot 22

Plot (23) is the diurnal pattern of the mean, maximum and minimum values of the grid frequency, the plot emphasizes the result obtained in Plot (22).

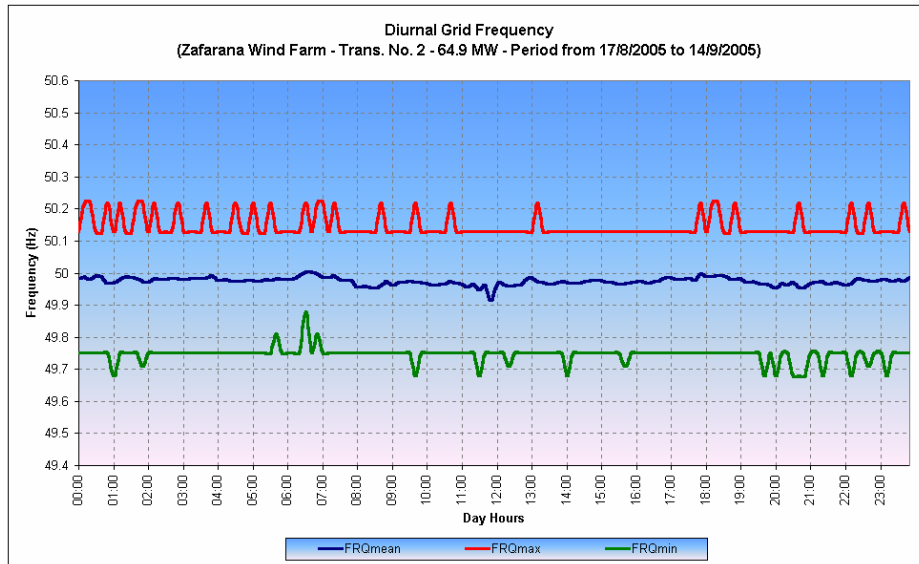

Plot 23

Plot (24) is the statistical data of mean, maximum and minimum values of grid frequency as 10-minute average value.

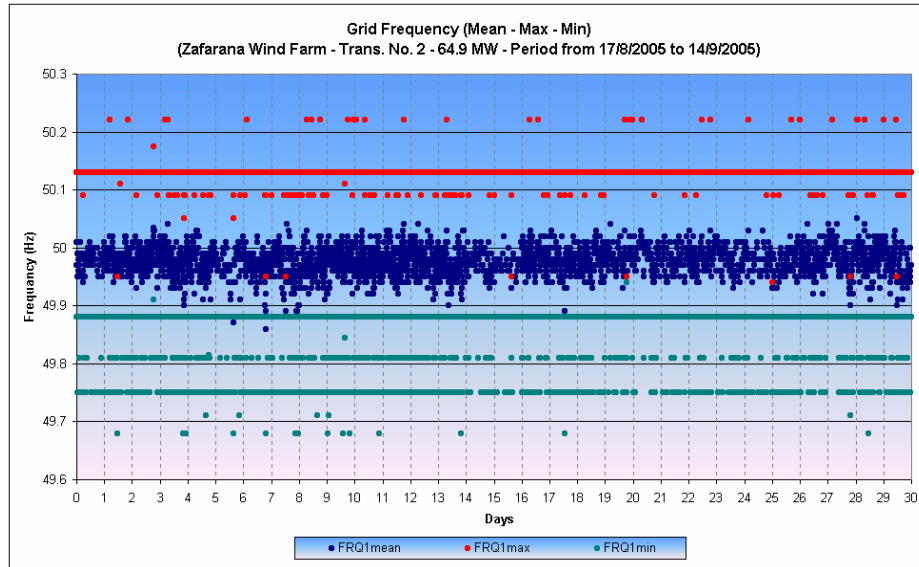

Plot 24

### 6.4 Voltage Harmonics

Plot (25) is the statistical data as 10-minutes average value of the Total Harmonic Distortion (THD) of the Bus-Bar voltage.

It can be seen from the plot that the measured THD within the measurement period are between 0.3 % and 3.11 %, which comply with the international standards (Voltage THD should less than 5% measured as 10-minute average) for supply voltage characteristics.

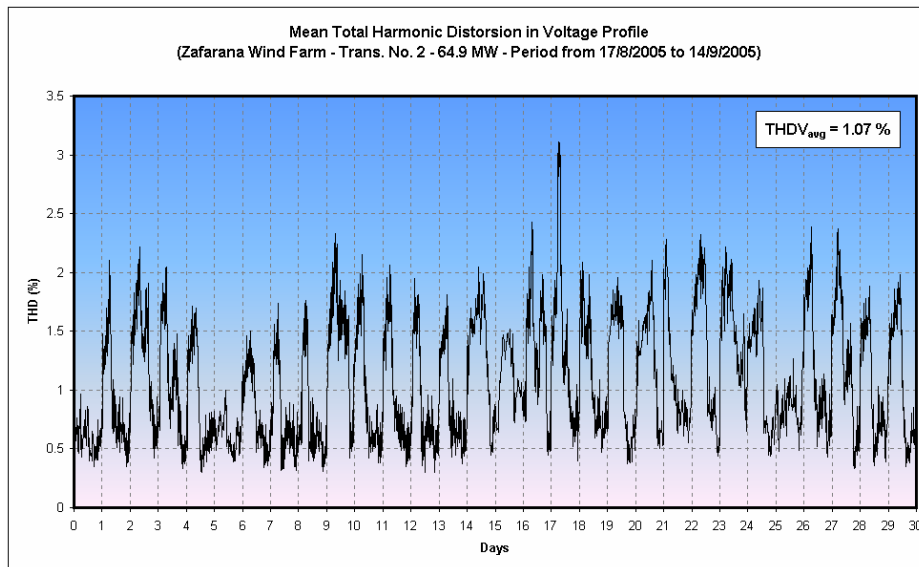

Plot 25

Plot (26) is the statistical data of a correlation between voltage THD and active power as 10-minute average value, the maximum value (3.11%) of THD occurred at 0.5 MW, indicating no particular relation between the output active power and the voltage THD, but the voltage THD follows the daily load pattern.

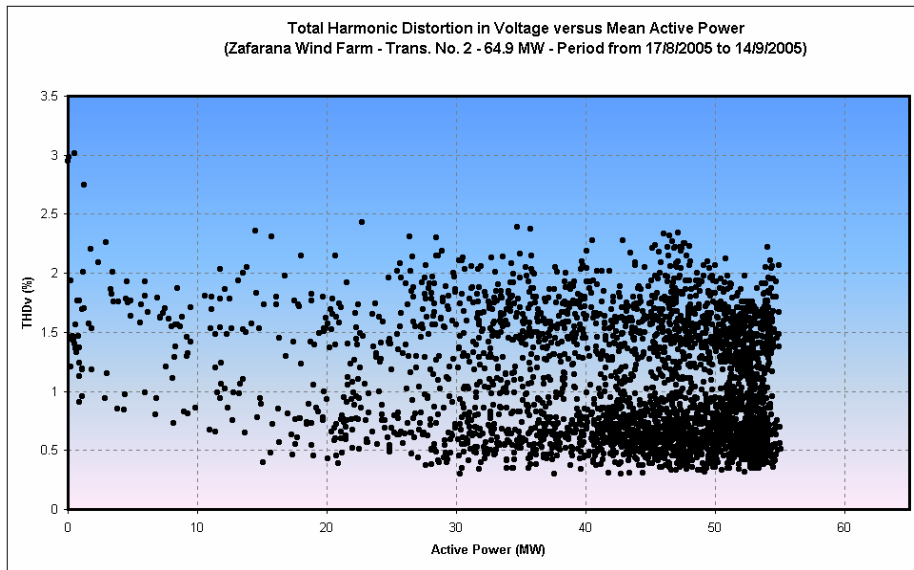

Plot 26

Plot (27) is the voltage THD in case of high and low wind speed, the plot emphasizes the fact that the wind turbines are not responsible for causing any significant harmonic distortion, in particular, the wind turbines at the site are fixed-speed with induction generator (without a power electronic converter).

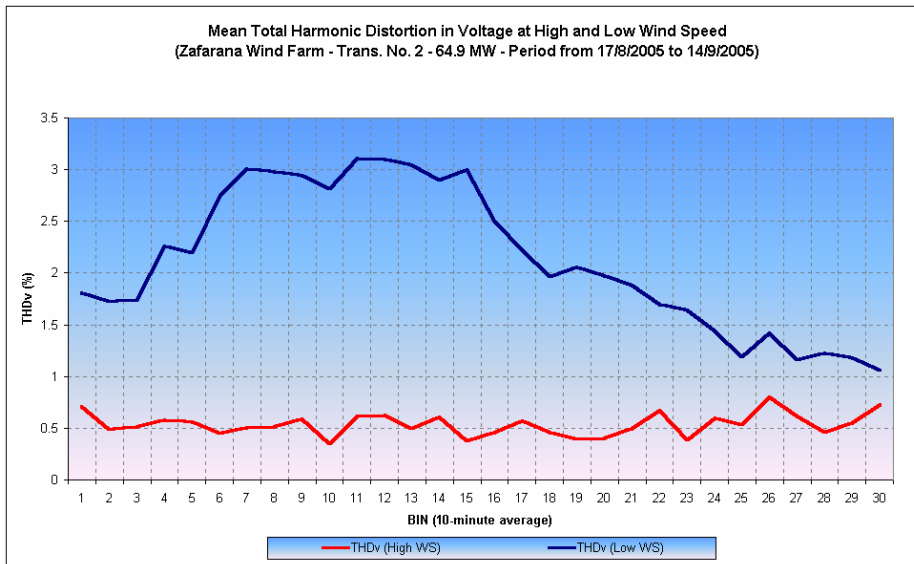

Plot 27

Plot (28) is the diurnal pattern of the mean and maximum values of the total harmonic distortion of the Bus-Bar voltage.

The plot is the typical voltage THD profile since the plot is the average value throughout the measurement period.

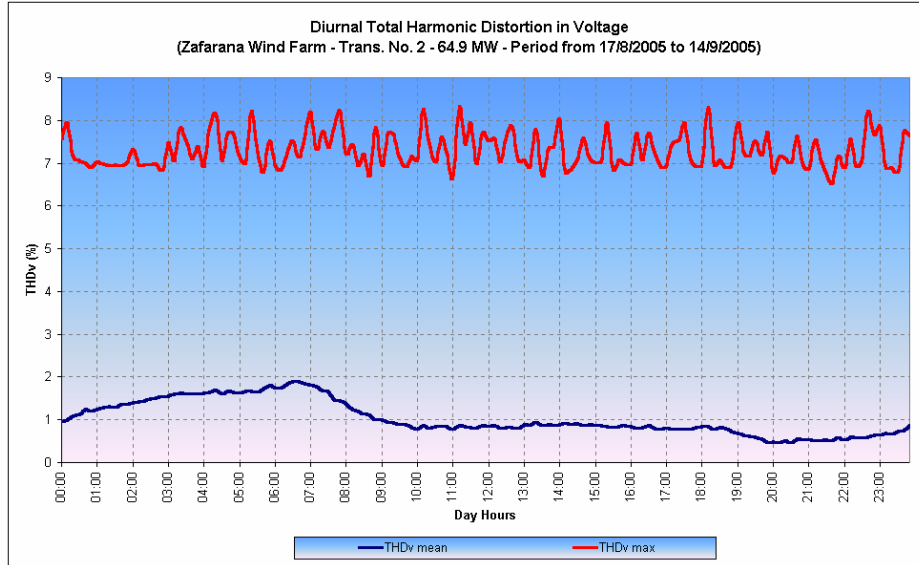

Plot 28

Plot (29) illustrate the absolute value of the frequency distribution of the voltage THD, the plot does not show any particular features except for a low mean value of THD.

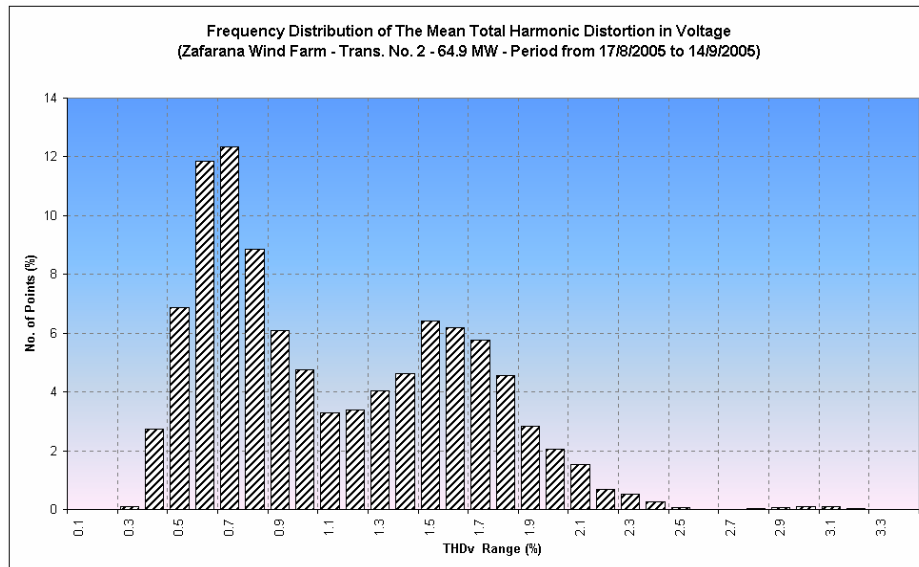

Plot 29

### 6.5 Current Harmonics

Plot (30) is the statistical data as 10-minute average value of the line current THD, it is clearly seen from the plot that there is a peak of 70 % of THD, and it is clarified that the peak corresponds with low wind speed during the measurement period.

However, the other situations in the plot show very low line THD which comply with the IEC.

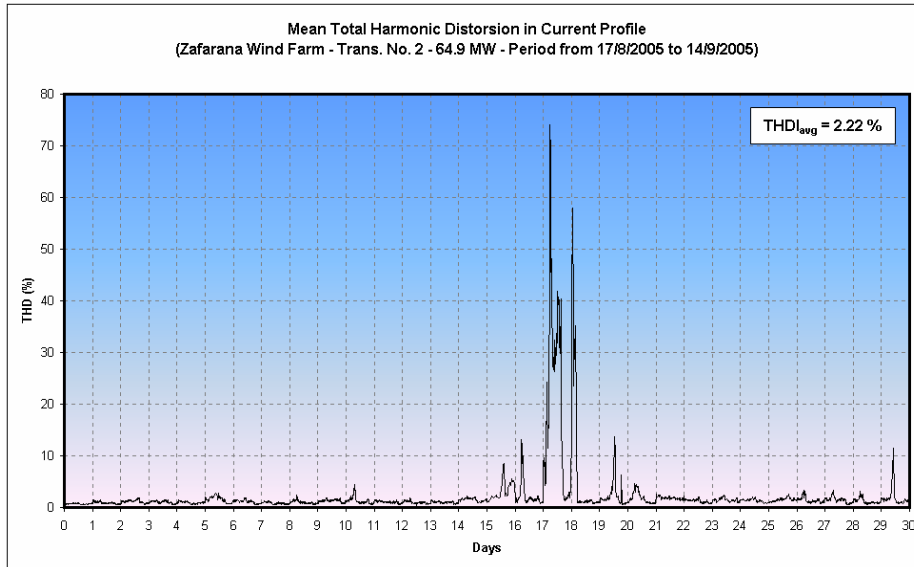

Plot 30

Plot (31) is the diurnal pattern of the mean and maximum values of the line current THD, the plot shows that the line current THD follows load pattern except for the situation of low wind speed.

The plot corresponds with the diurnal line current plot (Plot 12), i.e. maximum current THD occurred at minimum line current.

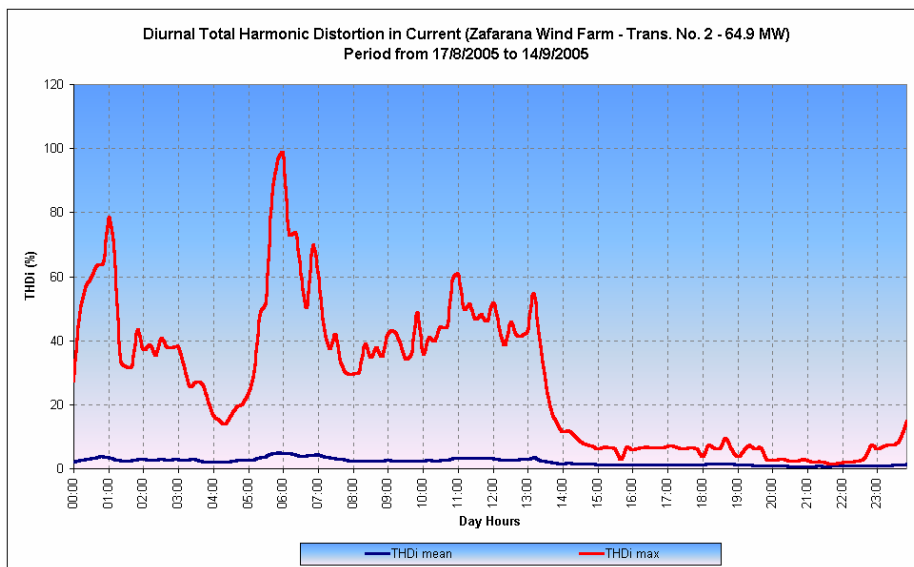

Plot 31

### 6.6 Consumed Reactive Power

Plot (32) is the statistical data as 10-minute average values of the consumed reactive power by the wind turbines. The mean value of the consumed reactive power is 17.22 kVAr during the measurement period.

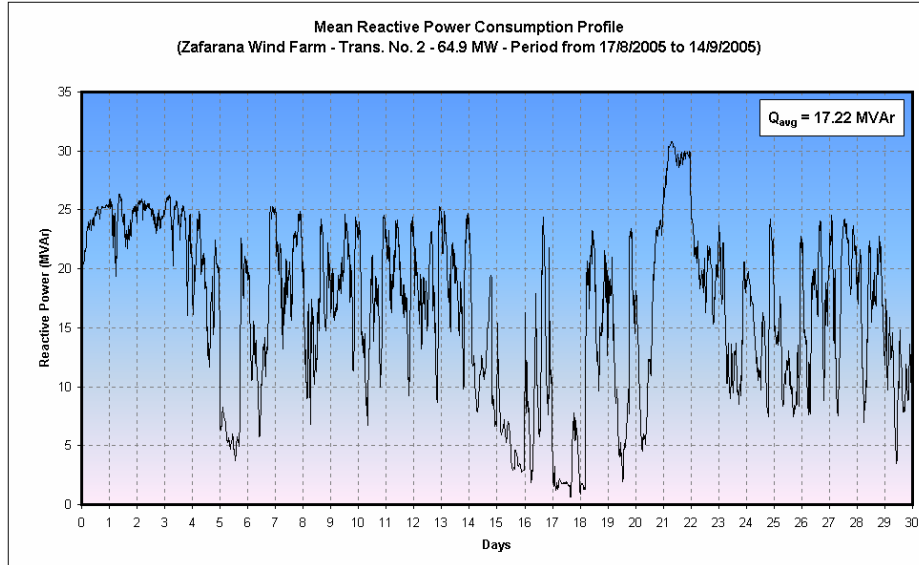

Plot 32

Plot (33) is the diurnal pattern of the mean, maximum and minimum values of the consumed reactive power.

The plot is the typical consumed reactive power profile since the graph is the average values of the measurements period.

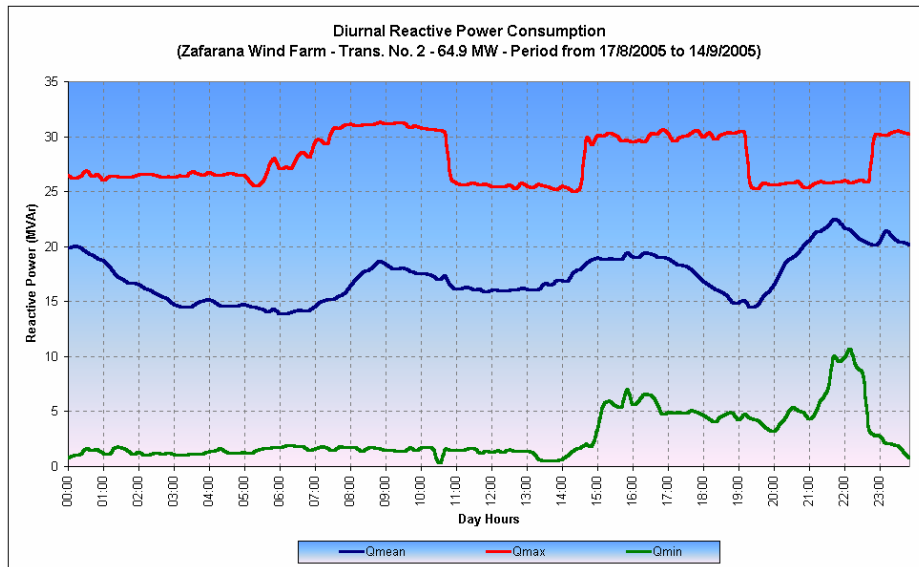

Plot 33

Plot (34) is the statistical data of the reactive power consumption as a function of active power production, the plot shows that the reactive power varies proportionally to the active power, even though the values are scattered when the active power is high.

The vague correlation between active and reactive power on day 7/9/2005 still needs for an interpretation, the consumed reactive power on that day looks higher than the active power.

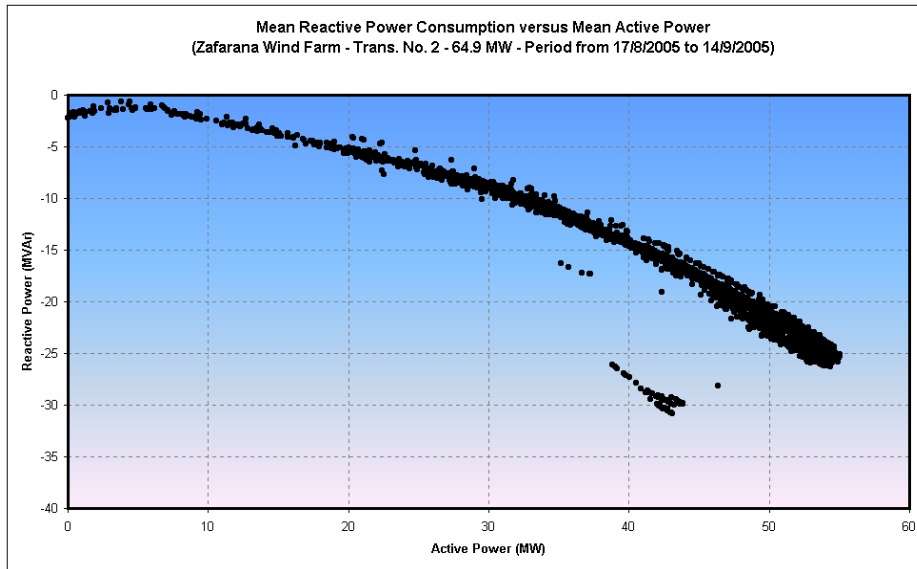

Plot 34

Plot (35) is the diurnal pattern of the consumed reactive power and the active power as mean value, the plot shows that the reactive power varies proportionally to the active power.

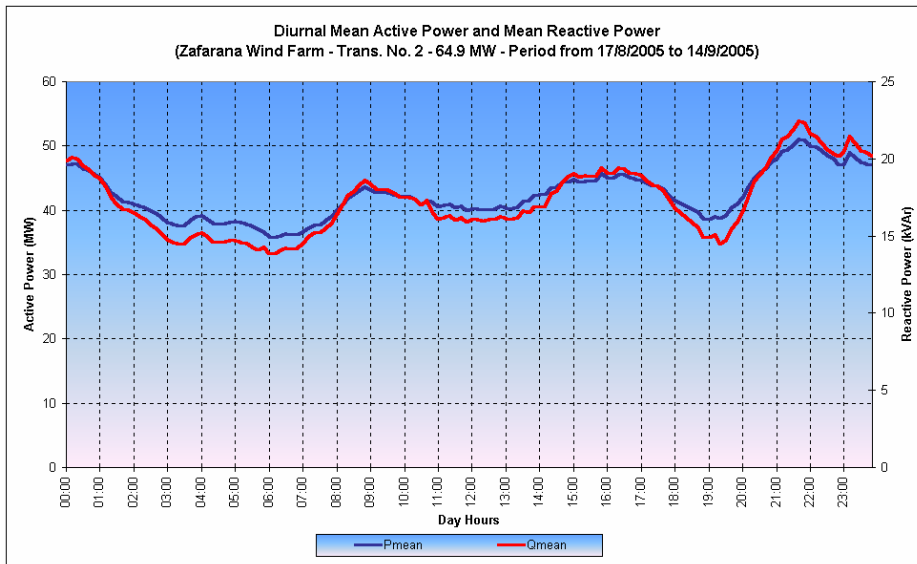

Plot 35

Plot (36) is the statistical data of a correlation between power factor and output power, the power factor looks reasonable at a value above 0.90 due to the two types of the wind turbines (Nordex – Vestas) are regulated by 200 kVAr and 250 kVAr of capacitor banks respectively.

The power factor “cos (φ)” has its maximum value of about 0.99 around 4.41 MW output power from the wind turbines.

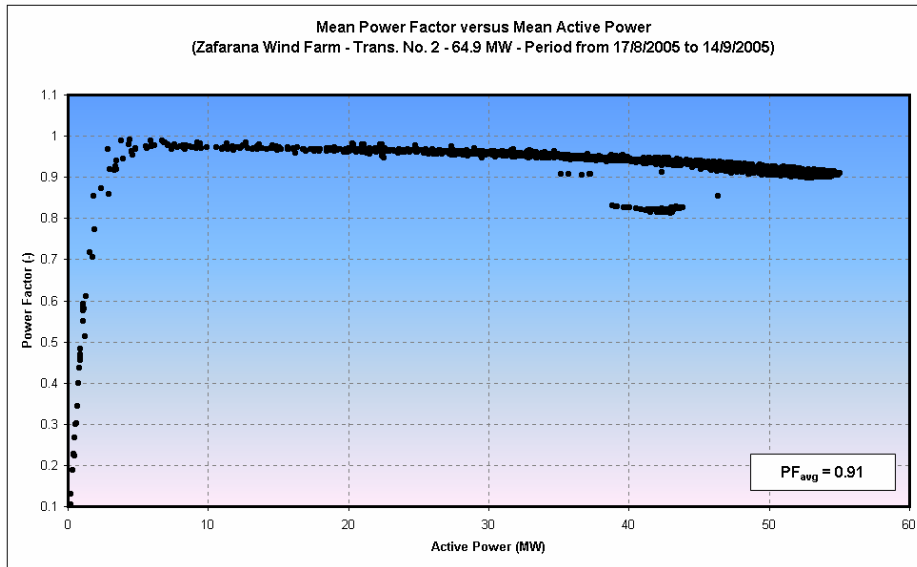

Plot 36

Plot (37) is the diurnal pattern of the power factor and active power as mean value, the plot shows that the power factor decreases for increasing the active power.

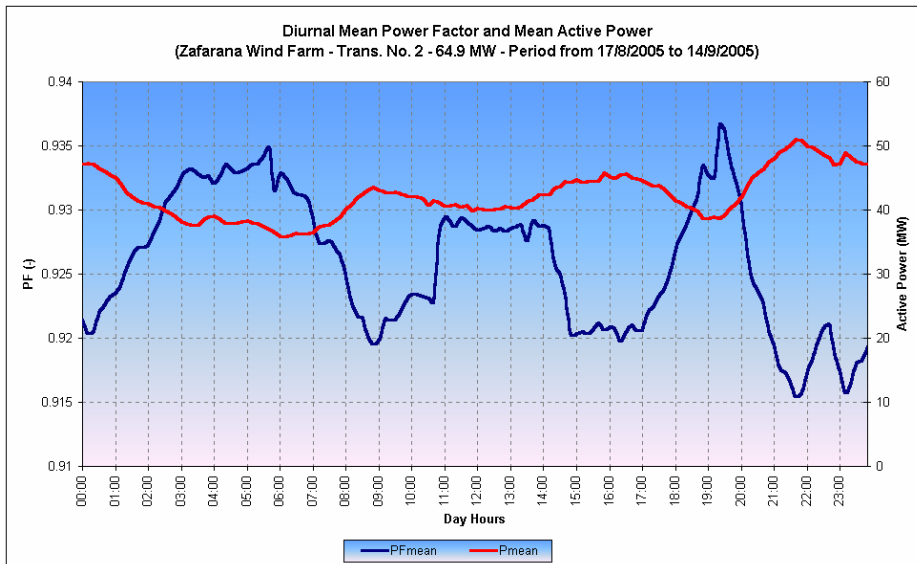

Plot 37



### 6.7 Produced Active Power

Plot (38) is the statistical data as 10-minute average of the output active power from the wind turbines, from the plot it is seen that the average value of the output active power is 42.12 MW during the measurement period, the plot corresponds with the line current plot (Plot 11).

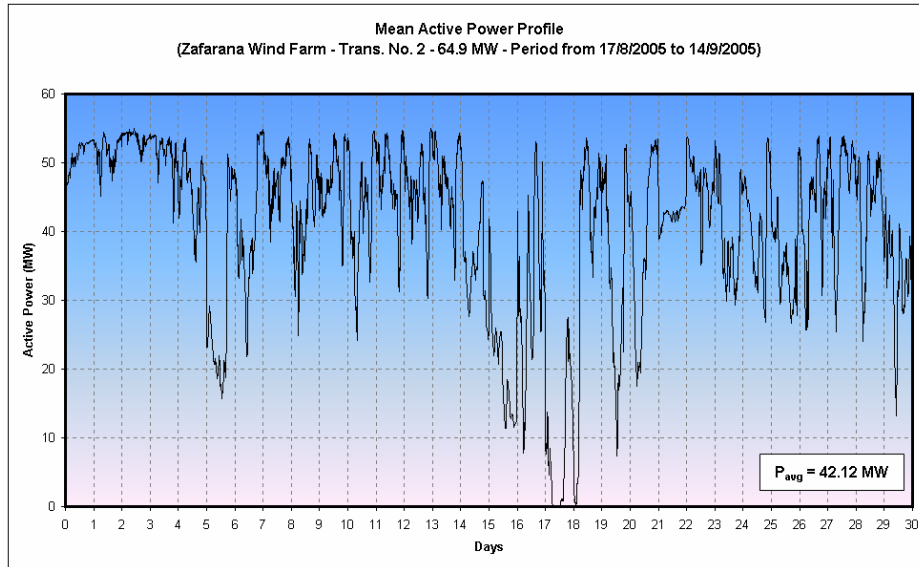

Plot 38

Plot (39) is the absolute value of the frequency distribution of statistical data as 10–minute average of the output active power from the wind turbines.

The distribution has a tail towards low production as well as the output active power varies from Zero MW to 55.06 MW as mean value and the majority of high active power data represent more than 60 % of the full data.

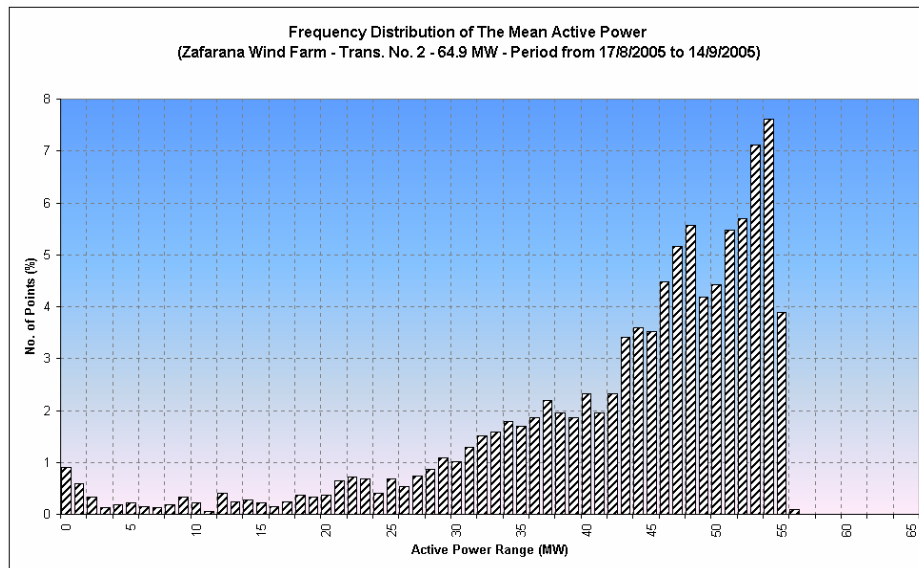

Plot 39

Plot (40) is the diurnal pattern of the mean, maximum and minimum of the active power value. The maximum value looks constant meanwhile the minimum value is somewhat does not show any particular features. The plot corresponds with the diurnal line current profile plot (Plot 12).

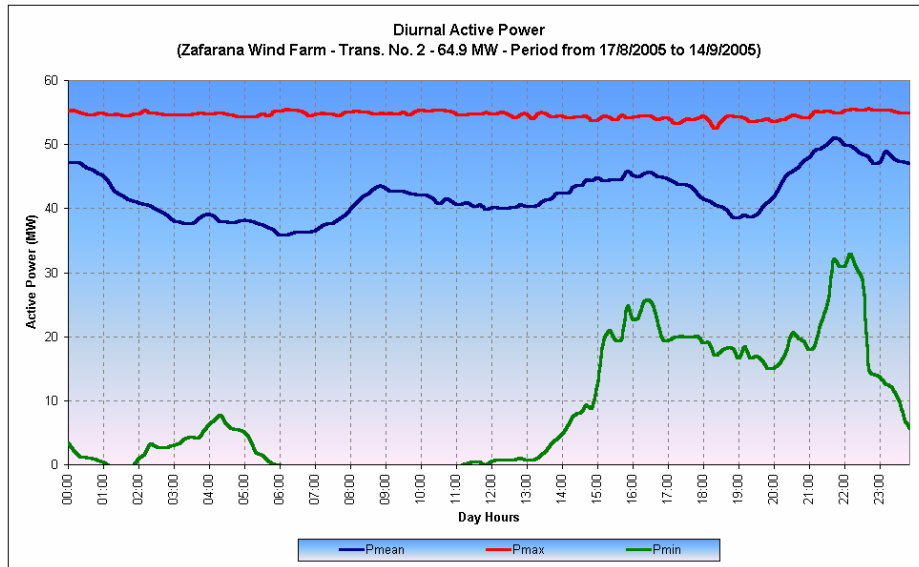

Plot 40

Plot (41) is the diurnal pattern of the active power and wind speed as mean value, it is observed that the wind speed is rather high during the measurement period, [Appendix 9, Table (5)].

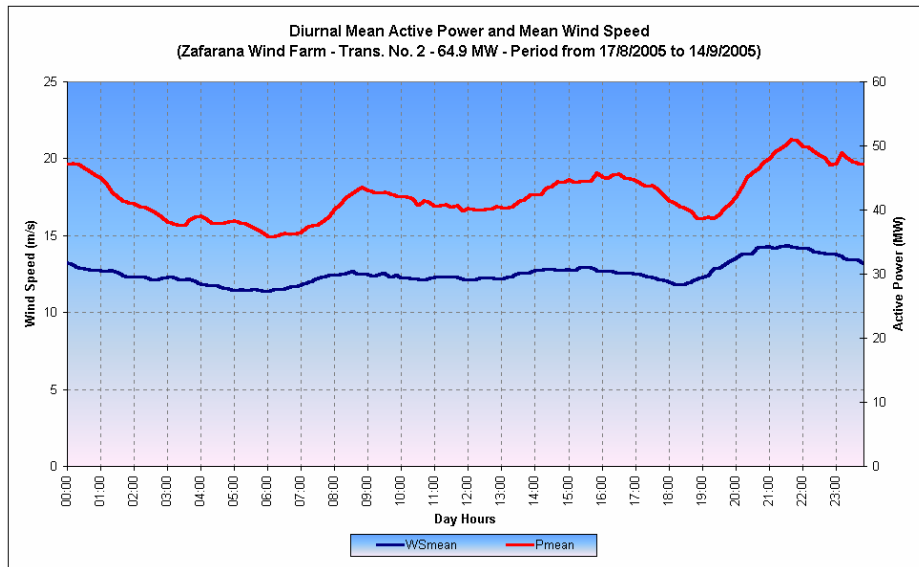

Plot 41

Plot (42) is the statistical data as 10-minute average values and the binned data (interval of 0.5 m/s) of the mean active power (uncorrected power curves).

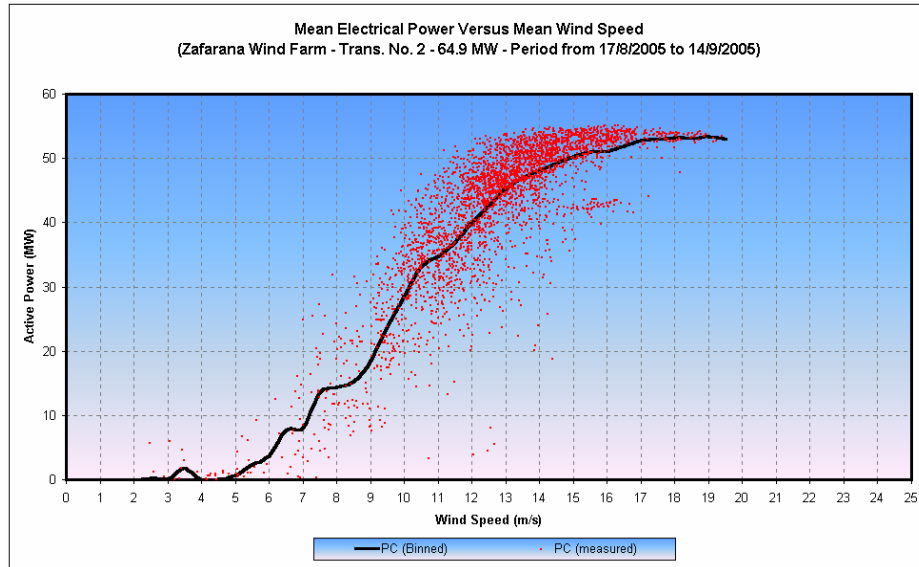

Plot 42

### 6.8 Capacity Factor

Plot (43) is the statistical data of the capacity factor (CF) as 10-minute average values, the average capacity factor during the measurement period is 64.94 %, which is quite high.

The capacity factor is determined according to the following equation:-

$$CF = \left[ \frac{Power_{act}}{Power_{theo}} \right] * 100$$

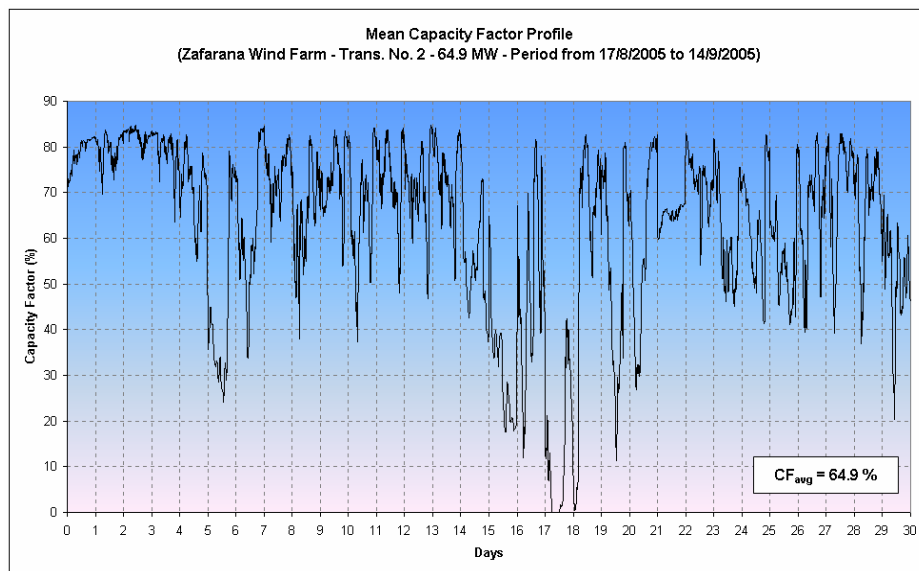

Plot 43

Plot (44) is the absolute value of the frequency distribution of statistical data as 10-minute average of the capacity factor, the capacity factor varies from zero to 85 % as mean value, and the majority of high values of CF represent more than 60 % of the full data.

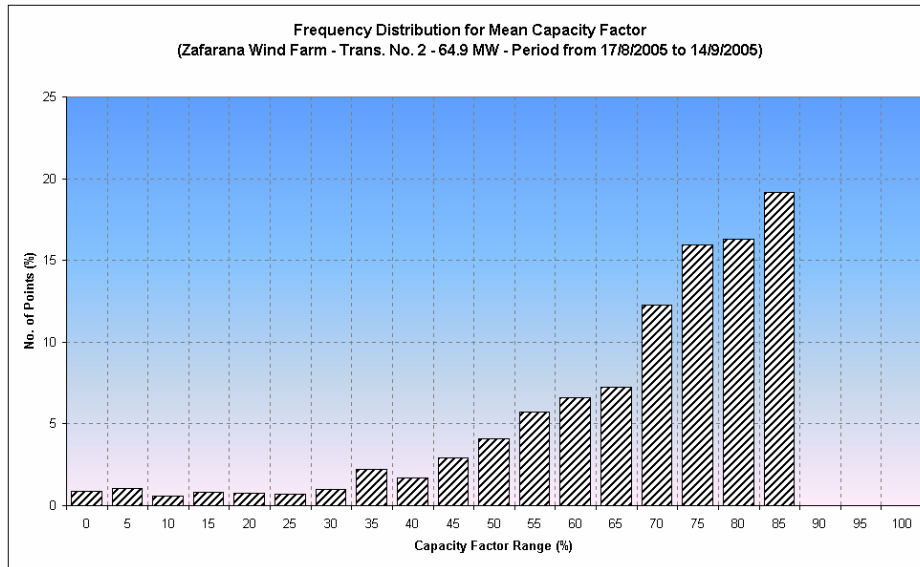

Plot 44

## 7. Conclusion and Recommendations

- ◆ During the measurement period the voltage level at Zafarana substation was between 21.06 kV and 22.73 kV, or in other words 22 kV +3.3 % and -4.27 %, International standard IEC (Ref 3) specifies that the voltage level should be within  $\pm 5\%$  of its nominal value measured as 10-minute average data or  $\pm 10\%$  of its measured instantaneous values. From the results obtained it could be stated that the voltage level when reaches to its maximum value still within the required limit, meanwhile it is critical when reaches to its minimum value.
- ◆ The voltage level at substation (point of connection of the wind turbines to the grid) depends on the output power from the wind turbines.
- ◆ The absolute value of the voltage changes lays in a narrow range and non-symmetrical around the nominal value, considering the wind farm connected to the 220 kV national grid.
- ◆ The maximum value of phase No.2 is 13.40 kV (12.7 kV + 5.50 % ) and minimum value of phase No.3 is 11.98 kV (12.7 kV -5.70 % ) , the two voltage limits are out of range.
- ◆ In case of adding more wind turbines, a through analysis must be executed, in particular voltage level.
- ◆ During the measurement period, the grid frequency was between 49.86 Hz and 50.13 Hz being within the required limits to comply with international standards on supply voltage characteristics.
- ◆ The load factor (mean / max ) is 96 % which is quite reasonable.
- ◆ During the measurement period, the measured total harmonic distortion THD of the voltage on day 7/9/2005 reached to 3.11% being within the required limit to comply with international standards on supply voltage characteristics.
- ◆ The total harmonic distortion in voltage is not due to the output power from the wind turbines, but follows the daily load pattern.
- ◆ No correspondence between harmonic amplitude and overall power output level.
- ◆ Fixed-speed wind turbines do not produce any harmonics; meanwhile variable-speed wind turbines may be produce different amounts and orders of harmonics depending on the type of inverter used.
- ◆ The maximum current THD occurred at minimum line current.
- ◆ The reactive power consumption of the wind farm increases for increasing output power.
- ◆ The maximum value of the power factor is 0.99 at output power 4.41 MW.
- ◆ The average capacity factor of the wind farm is 64.9 % during the measurement period.
- ◆ The majority of high active power data represent more than 60 % of the full data.
- ◆ The average wind speed throughout the measurement period is 12.69 m/s.
- ◆ No measurements were performed regarding power fluctuations, flicker, and transient since this kind of measurements requires specific instruments that were not available.

## 8. References

1. ***Isolated System with Wind Power, Results of Measurements in Egypt.***  
Henrik Bindner, Risø National Laboratory, Laila Saleh, Salah Abdel-Hafiez and El-Sayed Mansour, New and Renewable Energy Authority.
2. ***Hurghada Wind Energy Center (WETC), Demonstration Wind Farm Studies, Power Quality Assessment.***  
Jhon Tande, Poul Sorensen, Risø National Laboratory, Denmark, Mohamed Galal, Usama Naoman, El-Sayed Mansour, Amgad El-Hewehy, Ahmed El-Maghawry and Ibrahim Darweesh, New and Renewable Energy Authority.
3. ***Grid Interaction and power Quality of Wind Turbine Generator Systems.***  
Ake Larsson, Chalmers University of Technology.
4. ***The International Energy Community standard (IEC).***
5. ***The PM300 User Manual of RS232***



Table (3) The Output Statistical File (10-minute average) generated by using PM300STA.EXE program

DATE: 08-17-2005																		
SETUP FILE ZAF.SUP:																		
ZAF.CFG																		
ZAF.SEL																		
ZA050817.txt																		
19200	BAUD RATE																	
1000000	MEASUREMENT TIME (SEC)																	
10	SAMPLE TIME (SEC)																	
25	NUMBER OF MEASUREMENTS (CHANNELS) CORRESP TO SPECIF IN SELECTION FILE																	
CONFIGURATION FILE ZAF.CFG:																		
1 4	FAST OPERATING																	
2 0	3 PHASE 4 WIRE																	
4 1	FIXED AVERAGING																	
5 1	AVERAGING DEPTH																	
6 1	EXTERNAL CURRENT SHUNT																	
10 0	FIXED VOLTAGE RANGING																	
11 0	FIXED CURRENT RANGING																	
14 1	MANUAL FREQ SOURCE																	
15 1	FREQ SOURCE IS VOLTAGE																	
19 1	VOLTAGE HARM ENAB																	
23 11	HARMONIC ORDER																	
24 1	ODD HARMONICS																	
38 220	VOLTAGE SCALING																	
39 25	CURRENT SCALING																	
SELECTION FILE ZAF.SEL:																		
.SEL:CLR																		
.SEL:CH1; .SEL:CH2; .SEL:CH3; .SEL:SUM;																		
.SEL:WAT; .SEL:VAR; .SEL:VLT; .SEL:AMP; .SEL:VDF; .SEL:ADF																		
.SEL:FRQ																		
Number of channels 25																		
141000	19750200	15	14359467	133935	14654000	14173000	16019002	138924	16247000	15703000	15480866	120275	15659000	15221000	45860668	371927	46480000	45100000
142000	19750800	60	14843550	280991	15491000	14271000	16571886	318644	17202000	15945000	16010284	301280	16591000	15393000	47426330	892520	49200000	45700000
143000	19751400	60	14842849	183489	15280000	14454000	16528596	200685	16966000	16113000	15985852	191028	16401000	15637000	47357670	561379	48560000	46200000
144000	19752000	60	14710833	193369	15198000	14343000	16419083	199864	16867000	15956000	15857301	206120	16308000	15455000	46988164	588205	48350000	45870000
145000	19752600	60	14671218	215820	15128000	14175000	16350198	225484	16742000	15783000	15777753	214815	16137000	15275000	46799164	644503	47950000	45320000
150000	19753200	60	14803333	323210	15525000	14147000	16481184	345180	17209000	15802000	15923453	337013	16622000	15260000	47207825	997949	49350000	45210000
141000	19750200	15	6985533	94461	7210000	6775000	6399333	89867	6605000	6198000	6468800	85503.9	6682000	6303000	19914534	265796	20560000	19332000
142000	19750800	60	7256652	185742	7633000	6922000	6680016	183062	7063000	6355000	6760749	176794	7138000	6443000	20757700	545873	21900000	19779000
143000	19751400	60	7104884	140054	7392000	6863000	6526851	131285	6833000	6296000	6621349	128437	6918000	6405000	20312668	399336	21200000	19639000
144000	19752000	60	7228334	136180	7457000	6891000	6658749	130149	6876000	6352000	6757169	129504	6983000	6452000	20703046	393385	21350000	19745000
145000	19752600	60	7143616	194956	7491000	6682000	6559381	194982	6927000	6097000	6663401	196365	6985000	6211000	20425882	580580	21460000	19050000
150000	19753200	60	7128665	233542	7626000	6680000	6553399	228801	7014000	6112000	6654483	224433	7182000	6223000	20394767	685160	21880000	19083000
141000	19750200	15	12371.87	31.09	12427	12312	12750.47	15.56	12774	12707	12273.67	13.5	12290	12240	21589.33	26.13	21620	21540
142000	19750800	60	12366.42	34.78	12434	12298	12741	15.04	12777	12709	12265.15	9.69	12293	12243	21577	25.6	21620	21520
143000	19751400	60	12376.48	34.92	12441	12317	12747.33	15.29	12784	12719	12274.45	9.54	12301	12255	21591.83	27.62	21660	21540
144000	19752000	60	12355.52	31.7	12413	12295	12732.28	15.76	12766	12700	12256.87	12.64	12280	12225	21560.5	27.3	21620	21500
145000	19752600	60	12355.87	34.39	12414	12286	12722.7	24.96	12769	12648	12251.15	22.21	12293	12177	21552.67	38.01	21630	21440
150000	19753200	60	12375.03	32.58	12443	12320	12742.77	18.19	12775	12707	12269.07	14.43	12294	12241	21585.17	30.04	21650	21530
141000	19750200	15	1290.75	11.93	1311.5	1268.2	1352.91	12.34	1376.6	1324.3	1366.98	11.66	1389.4	1340.8	1336.89	11.84	1359.2	1311.1
142000	19750800	60	1336.14	27.34	1390.9	1286.4	1402.42	28.69	1458.2	1348.5	1416.98	28.6	1470.9	1361.9	1385.17	28.16	1438.6	1332.3
143000	19751400	60	1329.63	17.76	1369.7	1294	1394.11	19.14	1433.7	1356.3	1409.68	19.13	1449.2	1374.3	1377.81	18.62	1416.9	1341.5
144000	19752000	60	1326.64	18.05	1363.6	1288.2	1391.62	18.69	1430.5	1350.2	1406.33	19.66	1447.3	1364.9	1374.87	18.72	1413.8	1336.4
145000	19752600	60	1320.74	23.07	1360.4	1264.8	1384.76	23.34	1421.3	1329.7	1398.06	23.51	1434.3	1342	1367.85	23.2	1405.2	1312.3
150000	19753200	60	1327.77	32.13	1397	1262.7	1391.94	32.96	1459.6	1328.1	1406.67	33.47	1477.2	1341.8	1375.46	32.8	1444	1310.9
141000	19750200	15	50.01	0.08	50.13	49.88	50.01	0.08	50.13	49.88	50.01	0.08	50.13	49.88	0.57	0.25	0.89	0
142000	19750800	60	49.97	0.08	50.13	49.88	49.97	0.08	50.13	49.88	49.97	0.08	50.13	49.88	0.65	1.14	6.61	0
143000	19751400	60	49.99	0.09	50.13	49.88	49.99	0.09	50.13	49.88	49.99	0.09	50.13	49.88	0.51	0.2	0.89	0
144000	19752000	60	49.95	0.09	50.13	49.75	49.95	0.09	50.13	49.75	49.95	0.09	50.13	49.75	0.45	0.26	0.78	0
145000	19752600	60	49.96	0.08	50.13	49.75	49.96	0.08	50.13	49.75	49.96	0.08	50.13	49.75	0.68	1.29	6.33	0
150000	19753200	60	49.98	0.09	50.13	49.88	49.98	0.09	50.13	49.88	49.98	0.09	50.13	49.88	0.61	1.13	6.5	0
141000	19750200	15	0.66	0.32	1.51	0	0.72	0.14	1.08	0.57	0.68	0.58	1.28	0	1.06	0.48	1.86	0
142000	19750800	60	1.09	1.51	7.13	0	0.74	0.25	1.62	0	0.76	0.57	1.59	0	1.45	1.83	7.34	0
143000	19751400	60	0.71	0.76	6.09	0.44	0.61	0.13	1.12	0.45	0.87	0.39	1.25	0	1.12	1.04	6.5	0
144000	19752000	60	0.66	0.77	6.17	0	0.64	0.28	1.54	0	0.77	0.48	1.41	0	1.07	1.29	6.72	0
145000	19752600	60	0.71	1.05	6.17	0	0.57	0.21	1.34	0	0.63	0.49	1.32	0	1.18	1.65	6.55	0
150000	19753200	60	0.84	1.38	7.14	0	0.6	0.26	1.64	0	0.69	0.5	1.58	0	1.16	1.6	7.34	0
141000	19750200	15	0.98	0.3	1.3	0												
142000	19750800	60	1.21	0.98	6.4	0												
143000	19751400	60	0.99	0.16	1.33	0.59												
144000	19752000	60	0.86	0.28	1.27	0												
145000	19752600	60	0.79	0.34	1.24	0												
150000	19753200	60	1.05	1.01	6.29	0												

Table 3



Table (4) The Diurnal file (10-minute average) generated by PM300STA.EXE program

0	1413	12393.9	148.59	12899	12250	12966.8	145.304	13266	12607	12484.7	144.235	12775	12140	21965.3	251.181	22470	21370
10	1389	12394.4	145.778	12876	12284	12957.5	144.981	13258	12643	12475.3	143.090	12781	12180	21949.1	250.021	22450	21430
20	1440	12397.8	139.352	12865	12297	12960.9	137.545	13253	12670	12478.8	136.114	12746	12196	21955.1	237.317	22430	21470
30	1440	12391.3	128.736	12896	12214	12963	127.597	13250	12591	12481.9	126.259	12763	12118	21960.3	230.328	22480	21330
40	1440	12394.4	124.796	12894	12227	12967	122.541	13254	12595	12485.8	122.137	12781	12127	21966.8	212.688	22450	21340
50	1424	12611.8	129.490	12879	12206	12981.4	128.002	13250	12613	12503.6	127.488	12780	12153	21995.1	221.748	22440	21370
100	1394	12399.2	128.622	12837	12217	12967.4	128.423	13209	12617	12493.8	126.199	12729	12147	21974.2	219.423	22390	21360
110	1441	12596	131.259	12858	12216	12954.1	128.123	13227	12619	12481.6	128.778	12738	12147	21951.8	233.457	22400	21370
120	1300	12601.5	139.325	12922	12209	12967.4	136.746	13288	12615	12495.6	136.904	12904	12140	21976.5	237.758	22510	21350
130	1300	12613.3	137.964	12924	12234	12980.1	134.65	13287	12680	12508.6	135.273	12903	12188	21998.1	234.853	22510	21420
140	1300	12619.7	140.178	12942	12229	12986.7	136.427	13296	12638	12515.1	137.108	12919	12178	22009.3	238.299	22540	21400
150	1300	12625.3	137.905	12921	12251	12990.3	132.686	13282	12681	12520.7	134.894	12906	12197	22018	233.579	22520	21440
200	1300	12607.6	143.058	12890	12261	12970.9	138.447	13253	12683	12505	140.147	12774	12189	21987.4	242.981	22480	21440
210	1380	12398.1	143.574	12843	12239	12962	138.457	13195	12689	12496.5	140.115	12727	12188	21971.8	242.986	22390	21420
220	1380	12600.7	139.305	12841	12273	12963.3	136.194	13209	12671	12499.2	136.682	12735	12209	21975.8	237.225	22390	21430
230	1380	12611.8	139.867	12885	12209	12974.6	136.278	13208	12601	12509.6	137.031	12739	12156	21994.6	237.838	22400	21370
240	1380	12620	144.806	12907	12259	12982.9	141.432	13280	12614	12517.9	141.828	12778	12170	22009	246.308	22470	21400
250	1336	12631.2	138.390	12901	12312	12993.2	135.532	13235	12683	12528.5	135.995	12775	12218	22027.6	236.05	22480	21490
300	1300	12647	137.057	12939	12304	13009.5	134.53	13276	12696	12544.5	135.246	12787	12241	22055.2	234.423	22500	21520
310	1300	12652.7	140.472	12905	12303	13014.9	137.377	13241	12698	12550.1	138.025	12772	12248	22065	239.553	22450	21540
320	1300	12658.3	142.244	12917	12319	13019.6	138.598	13273	12697	12554.9	139.24	12780	12233	22072.5	241.989	22480	21510
330	1300	12658.5	141.858	12938	12315	13019.8	138.705	13273	12691	12554.5	138.087	12796	12225	22072.4	239.79	22510	21500
340	1300	12654.5	138.378	12926	12319	13018.8	133.332	13309	12713	12553	135.095	12821	12232	22069.9	234.288	22530	21510
350	1300	12657.1	138.758	12941	12324	13020	135.678	13319	12698	12554.7	136.319	12827	12243	22073	236.8	22580	21530
400	1300	12655.6	141.308	12951	12340	13019.4	136.796	13320	12706	12553.8	138.842	12835	12254	22071.4	240.078	22570	21540
410	1300	12664.8	148.217	12967	12332	13028.9	143.412	13334	12707	12562.7	145.491	12846	12250	22087.3	251.828	22590	21530
420	1300	12672	151.462	12991	12371	13035.9	147.529	13348	12735	12570.2	148.734	12870	12285	22099.7	257.891	22600	21600
430	1300	12673.2	152.591	12980	12379	13037.8	148.79	13347	12741	12571.4	149.735	12868	12286	22102.3	259.867	22620	21600
440	1440	12672.2	151.339	13004	12373	13037.4	147.405	13365	12745	12570.5	148.597	12876	12280	22100.9	257.778	22640	21600
450	1441	12674.6	154.549	13021	12378	13039.8	151.177	13375	12741	12572	152.275	12895	12284	22104.6	264.002	22680	21610
500	1440	12675.3	149.904	13045	12407	13041.1	147.838	13408	12751	12573.1	148.13	12906	12316	22108.4	258.873	22740	21630
510	1440	12675.5	148.221	13044	12409	13041.1	144.319	13405	12777	12573.4	145.803	12925	12317	22106.7	252.495	22730	21680
520	1440	12681.6	148.481	13067	12438	13047	144.465	13414	12800	12579.3	145.401	12958	12329	22117	252.497	22760	21700
530	1440	12687	144.307	13039	12441	13053	139.884	13397	12815	12585.6	141.432	12919	12344	22127.2	245.345	22720	21720
540	1441	12698.9	147.749	13033	12399	13064.4	143.847	13398	12792	12596.7	145.001	12917	12323	22147.1	251.871	22710	21670
550	1300	12693.8	153.898	13049	12421	13058.6	148.576	13408	12788	12592	150.871	12926	12326	22138.1	261.029	22730	21680
600	1300	12698.2	145.917	13035	12445	13062.1	141.189	13374	12808	12598.3	143.395	12910	12349	22145	248.098	22890	21720
610	1300	12696.9	148.101	13011	12402	13060.2	144.002	13359	12754	12594.8	146.354	12890	12300	22142.3	252.362	22850	21840
620	1300	12700.6	152.974	13030	12390	13065.1	148.226	13368	12745	12598.2	150.488	12900	12287	22149.5	260.33	22880	21610
630	1300	12710.8	155.348	13032	12379	13075.8	150.751	13380	12753	12608.6	152.306	12906	12297	22167.4	264.443	22890	21620
640	1300	12718.7	160.727	13043	12417	13081.2	155.123	13410	12779	12615	157.47	12900	12329	22177.7	272.886	22730	21680
650	1300	12717.5	165.706	13045	12409	13082.6	161.476	13397	12779	12616.3	163.35	12926	12312	22179.6	282.888	22720	21670
700	1300	12705.6	173.418	13084	12368	13070	168.198	13433	12717	12604.6	170.216	12957	12267	22158.6	294.995	22780	21570
710	1300	12691.9	178.331	13076	12358	13057.2	172.976	13430	12725	12591.4	174.79	12951	12257	22135.8	300.471	22770	21580
720	1300	12679.2	180.139	13067	12352	13044	174.434	13422	12719	12577.6	176.578	12953	12256	22112.8	306.352	22760	21530
730	1440	12674.7	180.897	13064	12328	13039.8	177.182	13421	12702	12573.2	178.028	12943	12232	22105.5	299.169	22750	21520
740	1440	12659.8	182.897	13058	12287	13024.6	178.485	13407	12683	12558.6	179.361	12940	12202	22079.7	311.741	22740	21450
750	1440	12645.9	181.880	13055	12280	13009.8	176.305	13403	12670	12543.1	178.371	12941	12181	22054.2	309.271	22730	21440
800	1440	12616.9	184.858	13027	12248	12980.6	180.304	13354	12652	12514.6	181.01	12893	12171	22004	314.715	22670	21410
810	1381	12585.9	186.242	12995	12258	12949.9	183.82	13347	12630	12483.8	183.894	12875	12158	21980.5	319.358	22630	21400
820	1380	12554.9	187.885	12982	12209	12919.4	184.82	13310	12603	12453.6	185.171	12844	12139	21897.7	321.802	22590	21350
830	1380	12532	188.891	12912	12229	12896.5	187.963	13286	12589	12430.1	186.892	12796	12135	21857.8	325.053	22490	21350
840	1320	12517.5	189.933	12891	12189	12882.7	189.727	13263	12587	12415.7	188.307	12781	12092	21832.9	327.838	22470	21270
850	1320	12504	186.498	12878	12218	12868.6	184.95	13229	12573	12400.1	183.565	12756	12121	21808.2	319.991	22430	21320
900	1288	12503.7	185.777	12850	12187	12870.3	184.358	13207	12541	12399.5	183.372	12735	12087	21808.6	319.022	22390	21280
910	1320	12511.4	195.87	12857	12162	12876	190.577	13218	12536	12405.4	193.315	12738	12049	21819.7	306.174	22400	21230
920	1280	12523.5	184.539	12820	12147	12889.9	180.098	13191	12520	12417.5	182.406	12725	12036	21841.6	317.2	22350	21200
930	1280	12521.2	177.829	12778	12154	12886.7	175.343	13149	12535	12415.6	175.177	12684	12039	21837.3	304.826	22270	21200
940	1280	12524.6	177.278	12800	12159	12890.5	176.582	13168	12539	12419.2	175.17	12686	12048	21843.5	305.078	22310	21220
950	1280	12533.8	180.813	12880	12145	12899.8	179.137	13238	12512	12428.3	177.811	12781	12031	21859.6	310.078	22440	21190
1000	1280	12538	183.815	12885	12143	12903	182.137	13240	12529	12431.6	181.199	12782	12042	21865.7	315.849	22450	21210
1010	1280	12531.6	185.778	12879	12148	12896.3	180.832	13229	12534	12425.1	180.202	12757	12044	21854.4	318.857	22430	21210
1020	122																

Table (5) The Average Wind Speed (Daily – Hourly) during measurement period from 17/8/2005 to 14/9/2005

Day Hours	Days															
	1	2	3	4	5	6	7	8	9	10	11	12	13	14	15	16
00:00	13.9	15.4	16.2	18.1	13.0	13.3	12.1	14.2	11.8	12.4	13.8	13.8	13.8	14.5	11.9	10.6
01:00	12.9	15.3	16.4	17.7	13.6	12.8	11.5	13.8	11.8	12.1	13.3	12.2	13.7	15.1	10.9	9.7
02:00	13.2	14.5	15.5	17.1	13.5	12.5	11.3	13.3	11.0	11.9	12.4	11.8	13.6	15.1	10.5	9.9
03:00	12.4	14.9	15.0	17.2	14.0	12.1	11.5	13.4	12.2	12.2	12.0	11.9	12.8	13.9	12.0	7.8
04:00	12.9	13.6	15.0	15.9	13.4	11.7	11.8	12.9	11.5	12.0	12.7	11.8	12.8	13.5	11.3	8.1
05:00	12.1	13.1	15.9	15.3	13.0	11.8	10.6	13.0	11.0	12.3	13.0	10.3	12.4	13.6	11.2	9.5
06:00	11.5	14.5	16.5	14.0	13.2	10.9	10.3	13.3	11.8	12.3	13.7	9.8	12.6	13.2	11.3	9.2
07:00	13.0	15.7	15.7	14.7	13.0	11.3	10.1	12.6	12.0	12.0	14.4	10.3	12.8	13.5	12.6	10.7
08:00	13.5	15.5	16.2	15.7	12.3	10.5	10.9	13.4	10.6	12.7	14.8	11.3	12.8	13.9	12.9	10.8
09:00	13.3	15.3	16.6	16.0	11.5	10.3	11.1	12.7	10.7	12.6	14.8	12.2	12.5	13.5	12.5	9.2
10:00	13.8	14.6	15.9	14.3	11.2	10.0	10.6	13.4	10.3	12.7	13.8	13.3	11.8	13.3	11.3	9.4
11:00	13.3	14.5	16.1	14.2	11.6	9.4	10.8	12.7	11.9	14.4	13.2	13.0	12.4	12.9	11.9	8.6
12:00	12.7	14.7	15.8	13.9	12.5	9.4	10.1	12.5	12.2	13.7	13.0	12.2	12.9	12.9	11.2	7.8
13:00	13.2	14.5	16.1	14.7	11.5	8.9	10.2	12.9	12.8	13.7	12.9	12.4	13.6	12.1	10.2	8.3
14:00	13.1	14.3	16.2	16.0	13.1	9.4	11.2	14.0	13.9	13.4	12.7	12.4	14.1	12.1	9.5	8.4
15:00	13.9	14.2	14.7	15.8	13.1	10.1	11.6	15.4	14.0	13.0	12.5	12.1	12.7	13.1	10.6	8.8
16:00	14.4	13.9	14.9	15.1	13.3	9.3	11.3	15.2	13.1	13.0	12.3	12.3	12.7	12.3	10.8	8.7
17:00	14.9	14.5	15.7	14.8	12.9	9.6	12.1	14.5	12.3	12.4	12.0	11.7	12.2	11.5	9.3	8.4
18:00	15.7	14.7	16.7	13.7	11.8	9.5	12.4	15.2	12.2	10.6	10.6	11.8	10.5	11.3	8.8	7.0
19:00	17.1	17.5	18.8	13.9	10.7	9.3	15.0	15.2	12.7	12.1	11.2	12.8	11.0	13.7	8.3	7.2
20:00	16.4	17.4	18.0	15.0	12.3	10.5	18.1	15.8	13.9	15.1	14.6	15.1	14.0	14.8	11.4	9.3
21:00	16.3	16.5	18.4	13.8	13.4	14.1	17.3	14.8	13.5	15.0	16.4	15.2	16.0	15.4	13.6	12.7
22:00	16.0	16.3	18.5	13.6	14.8	14.2	16.5	13.2	13.4	14.5	15.1	14.1	16.2	15.7	12.9	13.0
23:00	16.0	16.3	18.2	12.7	14.2	14.0	16.2	13.1	12.7	14.0	13.9	14.2	15.0	14.0	11.5	11.9
<b>AVG<sub>day</sub></b>	<b>14.0</b>	<b>15.1</b>	<b>16.4</b>	<b>15.1</b>	<b>12.8</b>	<b>11.0</b>	<b>12.3</b>	<b>13.8</b>	<b>12.2</b>	<b>12.9</b>	<b>13.3</b>	<b>12.4</b>	<b>13.1</b>	<b>13.5</b>	<b>11.2</b>	<b>9.4</b>
	<b>17</b>	<b>18</b>	<b>19</b>	<b>20</b>	<b>21</b>	<b>22</b>	<b>23</b>	<b>24</b>	<b>25</b>	<b>26</b>	<b>27</b>	<b>28</b>	<b>29</b>	<b>AVG<sub>hour</sub></b>		
00:00	11.2	7.6	4.9	13.3	11.3	14.9	14.3	13.3	12.5	12.7	13.4	13.9	13.4	<b>13.0</b>		
01:00	10.4	8.5	6.1	12.9	9.4	14.7	13.8	12.4	12.3	12.0	12.4	13.6	13.9	<b>12.6</b>		
02:00	10.2	7.8	7.1	11.7	9.3	15.1	13.9	12.0	11.1	12.8	12.2	12.4	12.5	<b>12.2</b>		
03:00	9.2	7.2	12.7	10.9	10.2	13.6	13.8	12.8	10.5	12.8	11.1	12.1	11.2	<b>12.2</b>		
04:00	7.4	5.8	13.3	9.5	11.3	14.2	13.7	12.9	9.4	11.2	10.4	10.3	10.3	<b>11.7</b>		
05:00	8.0	3.0	13.7	9.1	11.3	13.7	13.5	10.7	8.3	10.7	11.4	10.9	10.9	<b>11.5</b>		
06:00	9.1	2.8	14.5	7.9	12.6	14.0	13.1	10.6	8.0	10.7	10.3	11.8	12.0	<b>11.6</b>		
07:00	12.0	1.5	14.7	8.6	13.2	14.9	13.6	10.8	9.7	10.9	11.9	13.1	12.5	<b>12.1</b>		
08:00	11.9	2.3	14.0	9.4	14.0	15.9	14.6	10.7	10.7	11.6	12.6	14.3	13.7	<b>12.5</b>		
09:00	10.9	3.3	12.8	10.7	13.5	15.7	14.8	11.4	11.0	11.7	12.8	14.4	13.2	<b>12.4</b>		
10:00	9.8	4.2	13.0	11.8	13.0	15.5	14.1	10.2	11.0	12.2	12.9	14.4	12.4	<b>12.2</b>		
11:00	9.5	4.3	13.5	11.8	13.9	15.8	12.9	10.4	12.1	11.7	12.7	13.8	12.9	<b>12.3</b>		
12:00	10.7	4.9	13.5	11.9	14.5	15.7	13.4	10.4	11.7	10.5	12.0	14.6	12.9	<b>12.2</b>		
13:00	12.9	6.6	13.9	11.7	14.3	15.4	13.7	10.9	12.0	10.8	12.6	15.2	12.6	<b>12.4</b>		
14:00	13.1	8.5	13.3	11.5	14.8	14.8	14.1	10.9	12.3	10.6	13.8	15.5	13.3	<b>12.8</b>		
15:00	12.2	9.7	12.5	11.2	15.0	15.2	14.5	11.3	12.2	10.7	14.3	14.8	13.6	<b>12.8</b>		
16:00	11.3	9.1	12.2	11.1	15.2	16.0	14.0	11.1	12.1	10.6	12.9	14.6	13.7	<b>12.6</b>		
17:00	10.6	8.4	12.7	12.2	15.0	16.0	13.5	10.6	11.5	10.4	11.7	13.4	13.0	<b>12.3</b>		
18:00	9.9	9.1	12.0	13.9	14.2	15.1	13.7	10.1	10.4	10.4	10.8	12.1	12.8	<b>12.0</b>		
19:00	12.3	10.3	12.5	13.2	14.4	14.2	13.7	11.4	12.5	10.5	12.3	13.5	14.7	<b>12.8</b>		
20:00	11.3	11.7	14.2	13.7	14.8	13.7	14.3	11.9	13.8	11.1	12.9	15.0	14.0	<b>13.9</b>		
21:00	10.8	10.9	13.9	13.9	14.9	14.9	14.3	11.7	14.6	11.3	13.0	14.6	13.1	<b>14.3</b>		
22:00	8.9	9.1	13.2	12.2	14.6	15.7	13.4	13.3	14.6	12.9	13.5	13.9	12.6	<b>14.0</b>		
23:00	7.9	6.7	13.3	12.6	14.9	15.1	14.7	12.8	13.6	13.9	13.0	11.5		<b>13.5</b>		
<b>AVG<sub>day</sub></b>	<b>10.5</b>	<b>6.8</b>	<b>12.4</b>	<b>11.5</b>	<b>13.3</b>	<b>15.0</b>	<b>13.9</b>	<b>11.4</b>	<b>11.6</b>	<b>11.4</b>	<b>12.4</b>	<b>13.5</b>	<b>12.8</b>	<b>12.6</b>		

Hourly Average      Daily Average      Period Average

Table 5

Table (6) The Errors List occurred in Substation during the measurement period from 17/08/2005 to 14/09/2005

<b>The Transformers Substation Errors</b>					
<b>Transformer Number</b>	<b>Stop</b>		<b>Start</b>		<b>Notes</b>
	<b>Date</b>	<b>Time</b>	<b>Date</b>	<b>Time</b>	
<b>TR. 2</b>	05/09/2005	11:00	05/09/2005	14:00	

Table 6